



RICOH

RDC-5000

DIGITAL CAMERA

Operation Manual

To ensure correct use of your digital camera, read this manual carefully before use. Keep the manual handy for future reference.

Introduction

Thank you for purchasing a Ricoh digital camera. This manual explains the correct handling procedures and precautions for your camera. To ensure the best performance, please read the manual thoroughly before using the camera. Keep the manual handy for quick future reference.

Ricoh Co., Ltd.

Test Shots

Check that your camera is recording the images correctly by taking a number of test shots.

Copyright

Reproduction or alteration of copyrighted documents, magazines, music and other materials, other than for personal, home or similarly limited purposes, without the consent of the copyright holder is prohibited.

Exemption from Liability

Ricoh Co., Ltd. assumes no liability for failure to record or play back images caused by malfunction of the digital camera.

Warranty

This product is manufactured to local specifications and the warranty is valid within the country of purchase. Should the product fail or malfunction while you are abroad, the manufacturer assumes no responsibility for servicing the product locally or bearing the expenditure incurred therefor.

Radio Interference

Operating the digital camera in the vicinity of other electronic equipment may adversely affect the performance of both devices. In particular, operating the camera close to a radio or television may lead to interference. If interference occurs, follow the procedures below.

- Move the camera as far away as possible from the TV, radio or other device
- Reorient the TV or radio antenna.
- Plug the devices into separate electrical outlets.

- This publication may not be reproduced in whole or part without the express written permission of Ricoh. ©1999 Ricoh Co., Ltd. All rights reserved.
- Ricoh reserves the right to change the contents of this publication without notice. Considerable care was taken in preparing this manual. If, however, you have questions about any part of the manual, or note mistakes or inaccuracies, please contact us at the address listed on the back cover.

Microsoft, MS and Windows are registered trademarks of Microsoft Corporation in the United States of America and other countries. Macintosh is a registered trademark of Apple Computer, Inc., in the United States of America and other countries. All trademarked company and product names mentioned in this manual are the property of their respective owners.

Camera Features

● 2,300,000-pixel resolution compact camera

With a 2,300,000-pixel resolution CCD, the compact camera produces high-quality, high-resolution images (1792 × 1200). The camera is so light you can carry it with you anywhere.

● Immediate recording

Using the camera is as simple as clicking the shutter release button. Images thus shot are written to internal memory (8 MB) or a SmartMedia memory card (2/4/8/16/32 MB).

* Internal memory allow you to take pictures without the need for SmartMedia card.

● Instant playback

You can instantly review recorded image files simply by switching to Play mode. You can also magnify the images zoom playback or display several images at once (6-image display).

* SmartMedia memory cards let you exchange shot images with your friends.

● Multiple image recording modes

The RDC-5000 offers multiple image recording modes to suit your specific photographic needs, including F (Fine) mode, which puts the emphasis on image quality, N (Normal) and E (Economy) mode, which allows you to capture more images than any other mode.

● Wide shooting range

The 2.3× zoom lens allows you to capture subjects in a variety of compositions, from close-ups to shots with a background.

● Natural colors

The white balance feature allows you to capture a subject in its natural colors under any lighting conditions, indoors or outdoors.

● Close-ups

Macro mode for taking close-up shots at distances up to 4 cm (1.6 inches) (at wide) is ideally suited for taking flowers and small objects, etc.

● Monitors images on the TV screen

Connect the digital camera to a TV set with the video interface cable supplied and you can display your image files on the TV screen. You can also connect the camera to a video deck or video printer to dub the images onto a videotape or make full color prints.

● Transfers images to a PC

You can transfer the images onto a PC using software compatible with the digital camera. When loaded onto a PC, the images can be printed on a color printer or color copier.

Table of Contents

Camera Features	1
Table of Contents	2
Safety Precautions	5
Parts & Names	10
Explanation of LCD Monitor Displays	12
LCD Monitor	12
LCD Panel	14
Menus	16
Basic Operation/Quick Reference	20

Chapter 1 GETTING STARTED

Before Using the Camera	26
Checking the Package Contents	26
Attaching the Wrist Strap	26
Powering the Camera	27
Loading the AA Batteries	27
Using an AC Adapter	29
SmartMedia Memory Cards	31
What is a SmartMedia Memory Card?	31
Inserting a SmartMedia Memory Card	32
Formatting a SmartMedia Memory Card	33
Before You Start Recording	35
Setting the Date and Time	35
Adjusting the LCD Monitor Brightness	37
How To Hold the Camera	37

Chapter 2 BASIC SHOOTING

Basic Shooting	40
Operation Flow	40
Turning on the Camera	41
Selecting IN/CARD (Internal memory/SmartMedia memory card) Memory	42
Selecting a PIC (Image quality) Mode	43
Selecting a Recording Mode	44
Setting the Size of the Subject (Zoom)	45
How to View Images on the LCD Monitor	47
Shooting (Still Picture Mode)	48

Chapter 3 **ADVANCED SHOOTING**

Changing Recording Modes	52
Text Mode	52
Continuous Shooting Mode	53
Changing Flash Modes	55
Flash Off Mode	56
Auto Mode	57
Forced Flash Mode	58
Slow Synchro Mode	59
Setting the Exposure Compensation	60
Setting the Exposure Compensation	60
Changing the White Balance Mode	62
Daylight Mode	63
Cloudy Mode (Overcast Mode)	64
Tungsten Light Mode	65
Fluorescent Light Mode	66
Special Shooting Functions	67
Using the Self-Timer	67
Focus Lock Shooting	68
Manual Focus Shooting	70
Date Imprinting Mode	71
Redeye Reduction Mode	72
Monochrome Mode (Black & White) Sepia	73
Interval (Time lapse) Shooting Mode	74
Macro Shooting (Close-up Shooting)	76
S Mode (Shutter Speed)	77

Chapter 4 **PLAYBACK/ERASING**

Before Starting to Playback Recorded Images	80
Playback Display	80
Connecting to a TV	81
Playing Back a File	82
Operation Flow	82
Playing an Image File	83
Multi Image Playback	84
Zoom Playback	85
Auto Playback	86
Protecting a File	87
Playing a File Shot with Another Brand of Camera	88
Copying Image Files	89
Setting DPOF (Direct Print of File)	91
Setting a Printing Service	91

Erasing a File (Image)	94
Operation Flow	94
Erase	95
Erase All Images	96
Erase Selected Files (Images)	97

Chapter 5 MISCELLANEOUS

Transferring Images to a PC	100
Changing Camera Settings	102
Beep Sound Setting	102
Auto Power Off Setting	103
Changing OSD (On-Screen Display) Language	104
Changing Video-Out Signal Method (NTSC/PAL)	105
Keep Settings	106
Formatting Internal Memory	107
Displays the Current Version Information	108
Changing LCD Confirmation	109
Changing the LCD Setting	110
Initializing Settings	111
Using the Remote Control	112
Shooting	112
Playing	113
Erasing	114
Accessories	116
Handling Precautions	117
Care and Storage	118
Troubleshooting	119
Using Your Digital Camera in Other Countries	122
About the Warranty and Servicing	123
Specifications	125
Recording Capacities	127
Ricoh Service Offices	129

Safety Precautions

Warning Symbols

Various symbols are used throughout this instruction manual and on the product to prevent physical harm to you or other people and damage to property. The symbols and their meanings are explained below.

 **Warning** This symbol indicates matters that may lead to death or serious injury if ignored or incorrectly handled.

 **Caution** This symbol indicates matters that may lead to injury or physical damage if ignored or incorrectly handled.

Sample Warnings



The  symbol alerts you to actions that must be performed.



The  symbol alerts you to prohibited actions.

The  symbol may be combined with other symbols to indicate that a specific action is prohibited.

● Examples



Do not touch



Do not disassemble

Observe the following precautions to ensure safe use of this equipment.

Warning



- Turn off the power immediately in the event of irregularity, such as the equipment emitting smoke or a strange smell. Remove the batteries as soon as possible, being careful to avoid electric shocks or burns. If you are drawing power from a household electrical outlet, be sure to unplug the power cord from the outlet to avoid fire or electrical hazards. Discontinue use of the equipment immediately if it is malfunctioning. Contact the nearest service center at your earliest convenience.

Warning



- Turn off the power immediately if any metallic object, water, liquid or other foreign object gets into the equipment. Remove the batteries as soon as possible, being careful to avoid electric shocks or burns. If you are drawing power from a household electrical outlet, be sure to unplug the power cord from the outlet to avoid fire or electrical hazards. Discontinue use of the equipment immediately if it is malfunctioning. Contact the nearest service center at your earliest convenience.



- Avoid any contact with the liquid crystal inside the LCD monitor, should the monitor be damaged. Follow the emergency measures below in the following circumstances.
 - SKIN: If any of the liquid crystal gets on your skin, wipe it off and rinse the affected area thoroughly with water, then wash well with soap.
 - EYES: If it gets in your eyes, wash your eyes with clean water for at least 15 minutes and seek medical advice immediately.
 - INGESTION: If any of the liquid crystal is ingested, rinse the mouth out thoroughly with water. Have the victim drink a large amount of water and induce vomiting. Seek medical assistance immediately.



- Follow these precautions to prevent the batteries from leaking, overheating, igniting or exploding.
 - Do not use batteries other than those specifically recommended for the equipment.
 - Do not put the batteries in a fire, short-circuit the terminals, or attempt to disassemble, heat or recharge them. (Only nickel-cadmium (Ni-Cd) and nickel-metal-hydride (Ni-MH) batteries are rechargeable).
 - Do not use a mix of battery types. Avoid mixing different styles or classifications, batteries by different manufacturers, or old batteries with new.
 - Check that the batteries are loaded with the positive (+) and negative (–) terminals correctly oriented.
 - Do not solder the batteries.



- Do not mix rechargeable battery types or use batteries with substantially different charge statuses.

Warning



- Keep the batteries used in this equipment out of the reach of children to prevent accidental ingestion of harmful substances. Consumption of battery fluid is extremely harmful to human beings. If swallowed, seek immediate medical assistance.



Never use batteries in the following condition as this could lead to leaks, overheating, ignition, explosions or short circuits.

- Do not use batteries with insulation missing from around the negative (-) terminal.

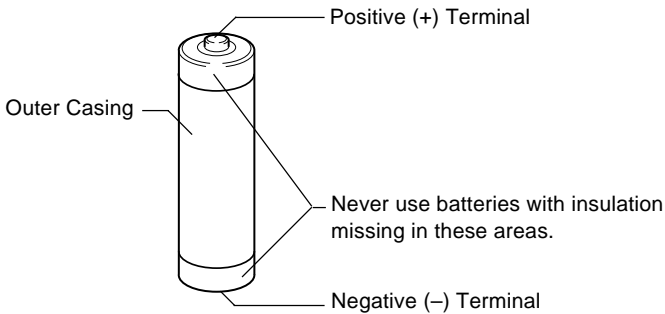

- Do not use batteries with outer casings that are damaged or missing.



- Keep the equipment out of the reach of children. Their inability to read and understand warnings and safety precautions may lead to accidents.



- Do not touch the internal components of the equipment if they become exposed as a result of being dropped or damaged. The high-voltage circuitry in the equipment could lead to an electric shock. Remove the batteries as soon as possible, being careful to avoid electric shocks or burns. Take the equipment to your nearest dealer or service center if it is damaged.



- Do not attempt to disassemble, repair or alter the equipment yourself. The high-voltage circuitry in the equipment poses significant electrical hazard.



- Do not use the equipment in the bathroom or shower as this could result in fire or electric shock.

Warning



- Do not use the equipment near flammable gases, gasoline, benzine, thinner or similar substances to avoid the risk of explosion, fire or burns.
- Do not use the equipment in aircraft or other locations where usage is restricted or prohibited as this may lead to disasters or accidents.



- Wipe off any dust that accumulates on the electrical plug as this may lead to fire.
- Use only the specified AC adapters for this equipment (optional AC-3) in household electrical outlets. Other adapters pose the risk of fire, electric shock or injury.



- To avoid the risk of fire, electric shock or injury, do not use the AC adapter with commercially available electronic transformers when traveling abroad.

Observe the following precautions to ensure safe use of this unit.

Caution



- Contact with fluid leaking from a battery can lead to burns. If part of your body comes in contact with a damaged battery, wash the area with water immediately. (Do not use soap.) If a battery starts to leak, remove it immediately from the equipment and wipe the battery chamber thoroughly before replacing it with a new battery.



- Plug the power cords securely into the electrical outlets. Loose cords pose a fire hazard.



- Do not allow the camera to get wet. In addition, do not operate it with wet hands. Both pose the risk of electric shock.



- Do not fire the flash at drivers of vehicles, such as bicycles, cars and trains, as this may cause the driver to lose control and result in a traffic accident.



- Do not grasp batteries with metallic tweezers as this may form a short circuit and lead to fire or electric shock.

Safety Warnings for Accessories

- Safety warnings for the optional accessories, such as the AC adapter, are contained in the instruction manual provided with each product and should be read thoroughly before operating the equipment.

Parts & Names

■ Camera Body

Front

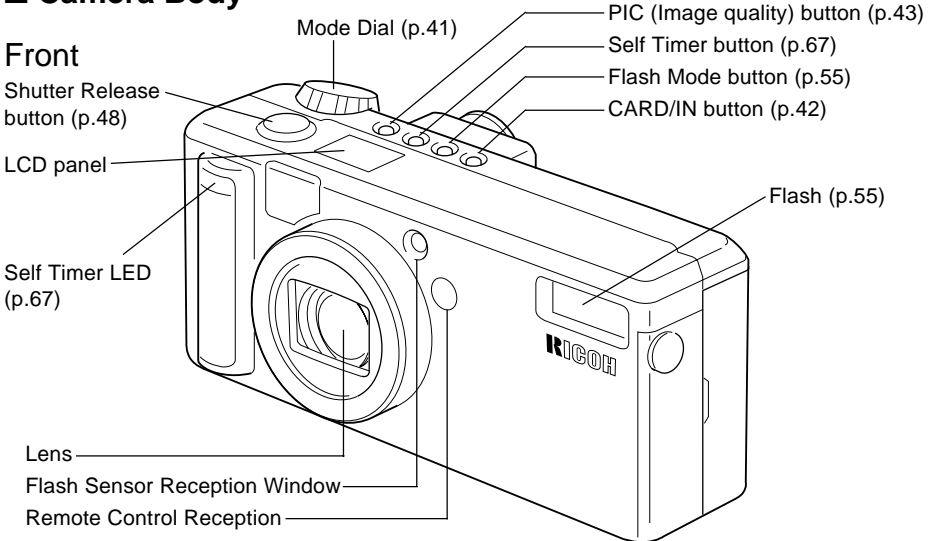

Back

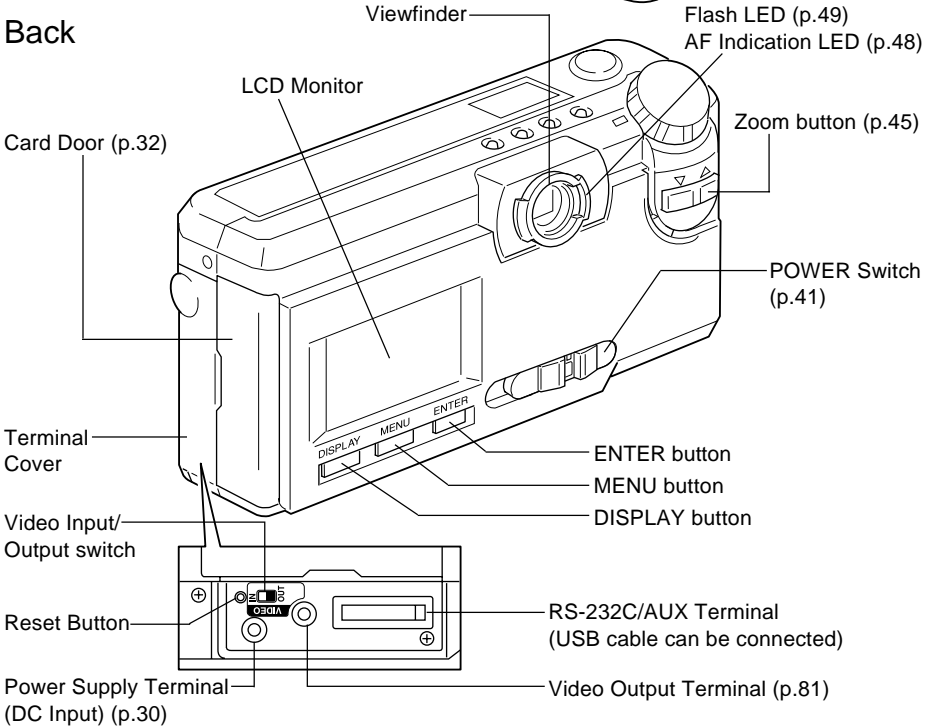

Bottom

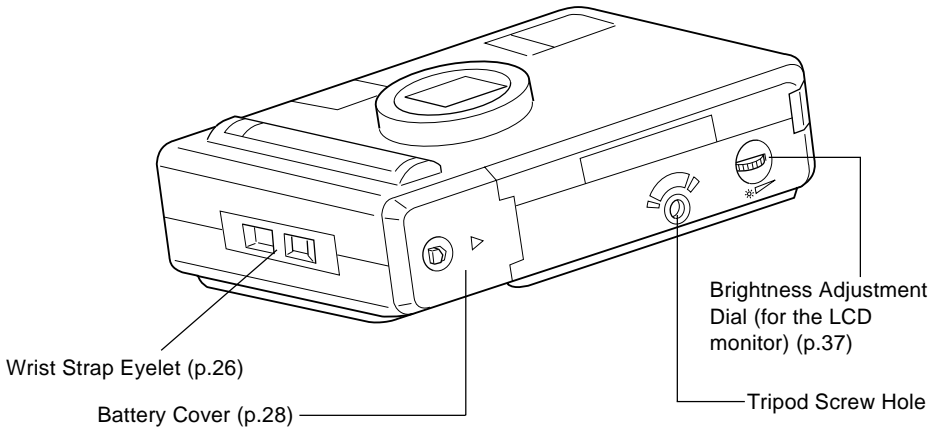

■ AC Adapter (optional)

- AC-3 (100V-240V)

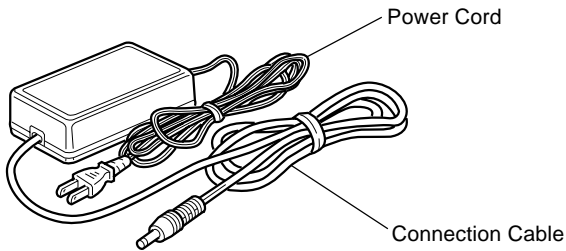

■ SmartMedia Memory Card (optional)

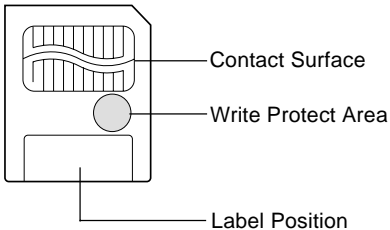

■ Remote Control Unit (optional) (DR-3)

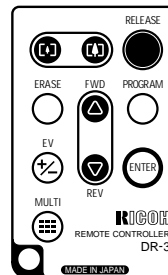

Explanation of LCD Monitor Displays

The LCD monitor or the LCD panel displays symbols and figures showing the status of your digital camera, such as the battery level, the number of pictures that can be taken, and the mode settings.

LCD Monitor

Recording Mode Displays

Red-eye reduction mode (p.72)

Flash Mode (p.55)

- Flash Off Mode (☺)
- Forced Flash Mode (♂)
- Slow Synchro Mode (♂: flashing)
- Auto Flash Mode (♂)

Recording Mode (p.44, 52)

- Still Picture Mode (□)
- Text Mode (□)
- Continuous shooting mode (☞)

Manual Focus Mode (p.70)

Zoom Indication Bar (p.45)

Exposure compensation level

Message Display

Date & Time Display (p.35)

White Balance Indicator (p.62)

- Auto (no symbol)
- Daylight Mode [☀]
- Cloudy Mode (Overcast Mode) (☁)
- Tungsten Light mode (☛)
- Fluorescent Light Mode (☎)

IN/CARD (internal card) memory (p.42)

- Internal memory (□)
- SmartMedia (□)

Recording Data Indicator

Displays the remaining number of pictures.

PIC (Image quality) Mode (p.43)

- 1800 × 1200/900 × 600 Fine Mode [F]
- 1800 × 1200/900 × 600 Normal Mode [N]
- 1800 × 1200/900 × 600 Economy Mode [E]

Battery Symbol (p.13, 29)

Self-Timer Mode (p.67)

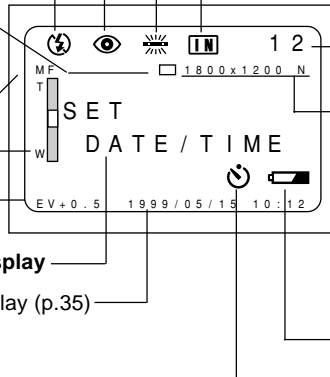

Play Mode Displays

Source for playback

- Internal memory (□)
- SmartMedia (□)

PIC (Image quality) Mode (p.83)

- 1800 × 1200/900 × 600 Fine Mode [F]
- 1800 × 1200/900 × 600 Normal Mode [N]
- 1800 × 1200/900 × 600 Economy Mode [E]

Recording Data

No. of the image file displayed.

Total no. of files recorded.

File Name

Name of the image file displayed.

Image Protect Mark (p.87)

Battery symbol

Shooting Date and Time

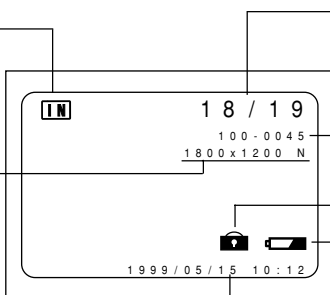



- All items of information are shown for illustration purposes. During actual camera operation, only the relevant items are displayed.
- The camera will switch off automatically (auto power-off) to conserve the battery if it is left idle (no buttons, switches or other controls operated) for about 5 minutes. To resume use, turn the camera on again.
- You can disable the auto power-off feature (p.103).
- The auto power-off mode does not function when the camera is powered by an AC adapter.

■ Warning Messages

If any of the warning messages listed below appears on the camera's LCD monitor, read the corresponding explanation and take the corrective action suggested.

Warning Message	Status	Explanation and Remedy	Reference Page
	Lit	Indicates low batteries. Have replacement batteries ready.	P. (27)
NO CARD	Flashing	A SmartMedia memory card is out of position. Mount a SmartMedia memory card.	P. (32)
WRITE PROTECTED	Flashing	A write-protected SmartMedia memory card is found. Remove the write protection label from the card to gain access to it.	P. (31)
FILE PROTECTED	Flashing	You attempted to erase a protected file. Unprotect the file before erasing it.	P. (87)
NO IMAGE	Lit	There are no files to play. Mount a SmartMedia memory card having files recorded on it.	P. (32)
UNMATCHED FILE	Flashing	You attempted to play an unplayable file.	P. (82)
FILE NUMBER OVER	Flashing	No more files can be recorded. Format the internal memory or insert a new SmartMedia memory card to continue recording.	P. (32, 107)
SET DATE/TIME	Flashing	The date has not been set. Set the date before starting operations with the camera.	P. (35)

■ Error Messages

If any of the error messages listed below appears on the camera's LCD monitor, read the corresponding explanation and take the corrective action suggested.

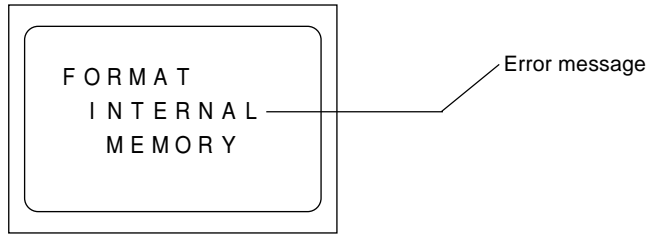

Error Message	Explanation and Remedy	Reference Page
FORMAT CARD	The SmartMedia memory card is unformatted. Format the card with the camera before using it.	P. (33)
FORMAT INTERNAL MEMORY	Format the internal memory before using it.	P. (107)
CARD ERROR	A SmartMedia memory card of this type is not supported by this camera.	—



If the error display does not clear, reset the LCD monitor to its factory default: How to reset: With the terminal cover open, press the reset button. If the error display still won't clear, call your dealer or our service contact.

LCD Panel

■ Initial display (SETUP mode)

The LCD panel appears blank.

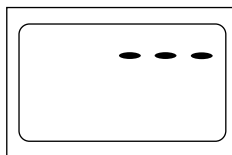

■ Displays Appearing during Recording

Battery Symbol (p.13, 29)

Recording Destination (p.42)

- Internal memory (INT)
- SmartMedia memory card (CARD)

Built-in Flash (p.55)

- Flash Off (⊗)
- Forced Flash (⚡)
- Slow Sync (⚡: blinking)
- Auto Flash (no mark appearing)

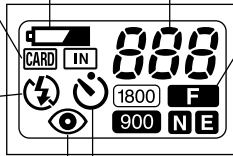

Recording Information Indicator

Displays the available picture count and the remaining recording time.

PIC Mode (p.43)

- 1800/900 Fine Mode (F)
- 1800/900 Normal Mode (N)
- 1800/900 Economy Mode (E)

Self-Timer (p.67)

Redeye Reduction Mode (p.72)



- The recording information indicator uses the letter L to designate the 100s place in the remaining number of files when it is 1,000 or more.
- In shooting with the digital zoom function enabled, only F, N or E is displayed as a PIC mode.

■ Displays Appearing during Playback/Erasre

Battery Symbol (p.13, 29)

Playback Source (p.80, 83)

- Internal memory (INT)
- SmartMedia memory card (CARD)

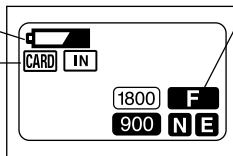

PIC Mode (p.43)

- 1800/900 Fine Mode (F)
- 1800/900 Normal Mode (N)
- 1800/900 Economy Mode (E)



- Either CARD or IN is displayed for files recorded on any other digital camera, such as a digital camera from the RDC-300/RDC-4000 Family (Ricoh) or one of non-Ricoh make.
- The PIC mode is not displayed when the multi-image playback or erase function is enabled.

■ Displays Appearing during Communication (Communication Mode)

- On an RS-232C cable connection

Battery Symbol (p.13, 29)

Recording Destination (p.42)

- Internal memory (INT)
- SmartMedia memory card (CARD)

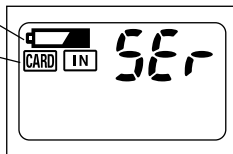

The LCD monitor displays the message "Waiting to communicate."

- On a USB cable connection

Battery Symbol (p.13, 29)

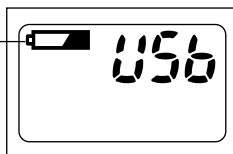

The LCD monitor displays nothing.

Menus

This camera features four menus which can be used to enter or change the settings for recording, playing or erasing image files.

■ SET UP Menu

With the camera turned on, set the mode dial to [SET UP]. To cancel the setup menu, turn the mode dial to select another mode.

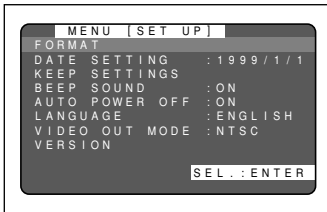

- FORMAT:** Formats internal memory or a SmartMedia memory card (which will erase protected, as well as unprotected, files). (p.33, 107)
- DATE SETTING:** Sets the date and time. (p.35)
- KEEP SETTINGS:** Saves camera settings. (p.106)
- BEEP SOUND:** Switches the electronic beep on and off. (p.102)

AUTO POWER

- OFF:** Enables or disables the auto power-off feature, whereby the camera switches off automatically when left idle for about 5 minutes or longer. (p.103)

- LANGUAGE:** Switches the LCD monitor display between Japanese and English. (p.104)

- VIDEO OUT MODE:** ... Switches the camera between NTSC and PAL when it is connected to a TV set. (p.105)

- VERSION:** Displays current version information about the camera. (p.108)

LCD

- CONFIRMATION:** Sets the confirmation time for images after shooting. (p.109)

- LCD SETTING:** Selects whether to let the camera come up with the LCD monitor enabled or disabled when it is powered on in a recording mode. (p.110)

INITIALIZE

- SETTING:** Initialize all the settings. (p.111)

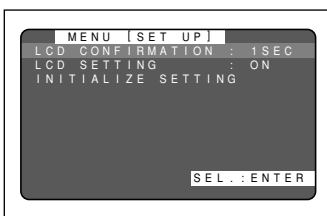

■ Record Menu

With the camera turned on, set the mode dial to [📷] and press the menu button. To exit the record menu, press the menu button again.

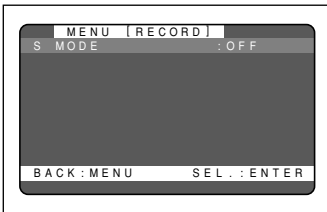
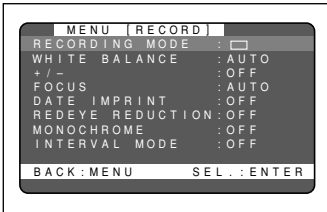

RECORDING

MODE: Switches between recording modes, such as text, continuous shooting and still picture (p.52).

WHITE BALANCE: Switches between the white balance settings (p.62).

+/- (Exposure compensation): Sets the exposure compensation (p.60).

FOCUS: Switches between auto focus and manual focus (p.70).

DATE IMPRINT: Records images with date. (p.71)

REDEYE REDUCTION:
..... Reduces the red-eye when shooting live subjects with flash. (p.72)

MONOCHROME: Records images in Black & White or sepia. (p.73)

INTERVAL MODE: Switches interval (time lapse) setting on and off (p.74).

S Mode: Sets the shutter speed to a faster setting for shooting in dim light (p.77).

■ Play Menu

With the camera turned on, set the mode dial to [▶] and press the menu button. To exit the play menu, press the menu button again.

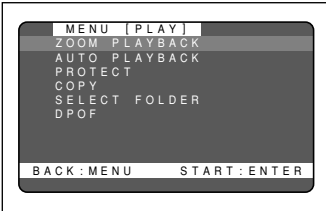

- ZOOM PLAYBACK: ...** Displays an enlarged image. (p.85)
- AUTO PLAYBACK: ...** Plays all images automatically within a preset length of time. (p.86)
- PROTECT:** Protects image files from erasure. (p.87)
- COPY:** Copies shot images from internal memory to a SmartMedia memory card, and vice versa. (p.89)
- SELECT FOLDER:** Plays images shot with another brand of camera. (p.88)
- DPOF:** Select this function to generate recorded images for submission to digital printing services or other applications. (p.91)

Erase Menu

With the camera turned on, set the mode dial to [🗑️]. To exit the erase menu, set the mode dial to another mode.

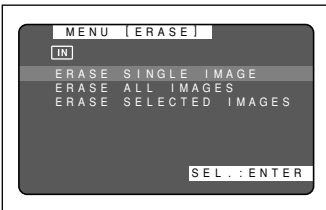

- ERASE SINGLE IMAGE:** Erases selected images one at a time (except protected images) (p.95).
- ERASE ALL IMAGES:** Erases all the files from the card (except protected images) (p.96).
- ERASE SELECTED IMAGES:** Erases multiple selected images (except for protected files) at once. (p.97)



- The [PC] setting on the mode dial is used to transfer image files from the camera to a PC.

Basic Operation/Quick Reference

This section provides introductory information about the Ricoh RDC-5000 digital camera. Further details can be found in the reference pages mentioned below.

Preparations

Loading the Batteries (p.27-29)

① Load the batteries into the camera.

- * When using an AC adapter, connect it to the camera and then to the AC outlet. (p.29)

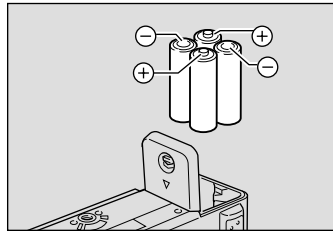
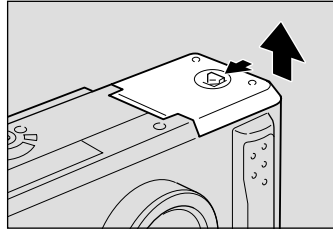

Inserting a SmartMedia Memory Card (p.32-33)



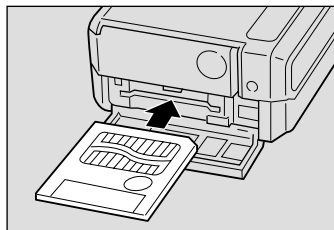
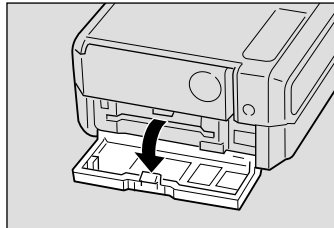

① Make sure that the camera is turned off.

② Open the card door and insert a SmartMedia memory card.

- Before using a new SmartMedia memory card, you must first format (initialize) it with the camera. (p.33)



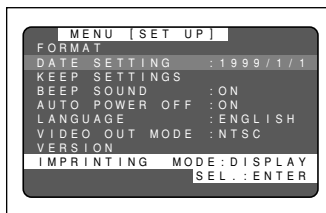

Setting the Date and Time (p.35-37)

- ① Slide the power switch and set the mode dial to [SET UP].
- ② Press the  or  button to select [DATE SETTING].
- ③ Press the DISPLAY button to select the display method.
- ④ Press the ENTER button.
- ⑤ Press the  or  button to change the flashing digit.
- ⑥ Press the ENTER button.
Repeat steps ⑤ and ⑥ above to complete the settings.
* Each time you press the ENTER button, the flashing digit changes, from year to month, day, hour and minute.
- ⑦ After you have set the number of minutes, press the ENTER button.



Shooting

Basic Shooting Procedure (p.40-50)

- ① Slide the power switch and set the mode dial to .
- ② Press the CARD/IN button to select where to record.
- ③ Press the PIC button to select a PIC (Image quality) mode.
- ④ Select a recording mode.
 - ① Press the MENU button to display the record menu and select [RECORDING MODE].
 - ② Press the ENTER button to select a recording mode and then press the MENU button to return to the original display.
- ⑤ Press the  or  button to select the desired size of the subject.
* Observe the position of the subject by looking through the viewfinder or at the LCD monitor.
- ⑥ Press the shutter release button to record the image.

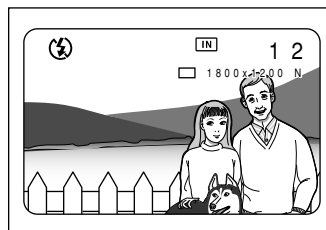
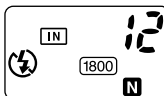
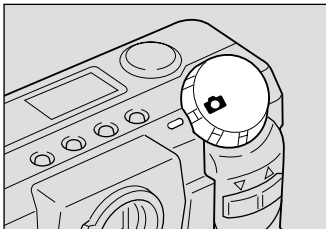

Changing the Flash Mode (p.55-59)

- 1 Set the mode dial to [📷].
- 2 Press the flash mode button to select a flash mode.

You can choose Flash Off (🚫), Auto (⚡), Forced Flash (⚡), or Slow synchro mode (⚡).

The selected mark will be displayed on the LCD monitor or on the LCD panel.

- 3 Press the shutter release button to record the image.

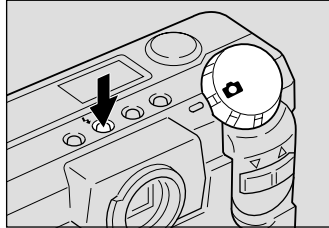
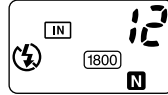

Using the Self-Timer (p.67-68)

- 1 Set the mode dial to [📷].
- 2 Press the self timer button.

The self timer is now set.

The ⌚ mark will be displayed on the LCD monitor or on the LCD panel.

- 3 Press the shutter release button to record the image.

The self timer LED will start flashing and the shutter will be released after a delay of about 10 seconds.

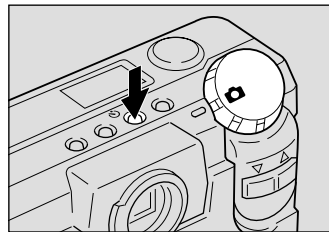
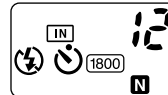

Playback

Playing Back Files (p.82-83)

- 1 Slide the power switch on and set the mode dial to [▶].
- 2 Press the or button to select a file you wish to view

* The multi-image and zoom playback features allow you to view several image files at once or magnify an image. (p.84, 85)

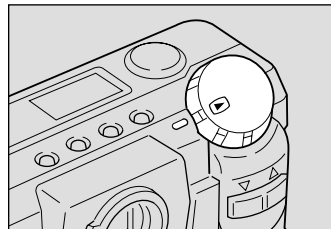

Erasing

Erasing Files (p.94-97)

- 1 Slide the power switch on and set the mode dial to [W].

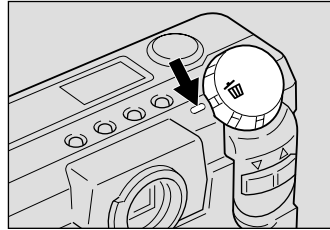

- 2 Press the **Q** or **W** button to select the erase mode and press the ENTER button.

* Remember that files cannot be restored once they are erased. Before starting to erase a file, make sure that you want to erase it.



If you selected [ERASE SINGLE IMAGE]

- 3 Press the **Q** or **W** button to select a file you want to erase and press the shutter release button.

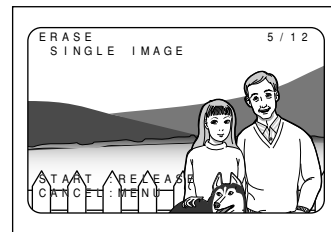

If you selected [ERASE ALL IMAGES]

- 3 Press the shutter release button.



If you selected [ERASE SELECTED IMAGES]

- 3 Press the **Q** or **W** button to select a file you want to erase and press the ENTER button.

Repeat step 3, as needed, to erase additional files at a time. And press the enter button again to cancel the erasure setting.

- 4 Press the shutter release button.

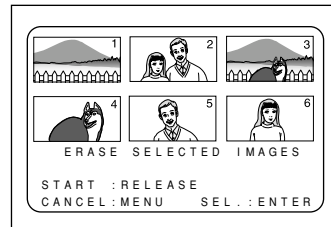

GETTING STARTED Chapter

1

Before Using the Camera	26
Checking the Package Contents	26
Attaching the Wrist Strap	26
Powering the Camera	27
Loading the AA Batteries	27
Using an AC Adapter	29
SmartMedia Memory Cards	31
What is a SmartMedia Memory Card?	31
Inserting a SmartMedia Memory Card	32
Formatting a SmartMedia Memory Card	33
Before You Start Recording	35
Setting the Date and Time	35
Adjusting the LCD Monitor Brightness	37
How to Hold the Camera	37

Before Using the Camera

Checking the Package Contents

Check that your digital camera comes complete with all the accessories listed below. Read the warranty card and keep it in a safe place.

- Digital camera: 1
- Video interface cable: 1
- Soft case: 1
- AA alkaline batteries: 4
- Wrist strap: 1
- Operation manual (this manual): 1
- Warranty card: 1
- PC connection cable (RS-232C) 1
- Macintosh cable (AUX) 1
- USB cable 1
- Software CD-ROM 1

Attaching the Wrist Strap

Attach the wrist strap provided to prevent the camera from being dropped during use.

- 1 Pass the small loop of the strap through the wrist strap eyelet and pass the other end through the loop as illustrated.



- Do not swing the camera around by its strap.

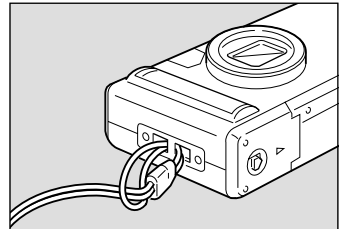

Powering the Camera

This section explains how to load the batteries (AA alkaline batteries) into the camera and how to connect the AC adapter to power the camera from a household electrical outlet.

Loading the AA Batteries

Mount AA batteries and operate the camera.



- If you use commercial batteries, use of rechargeable AA batteries (nickel-cadmium or nickel-metal-hydride batteries) is recommended.

Rechargeable Batteries

- Before using commercially available rechargeable AA Ni-Cd or AA Ni-MH batteries, read the safety precautions in the accompanying manual.



- Use only the specified AA batteries.
- Never use batteries of an unrecommended type, such as manganese battery, as this could damage the camera or LCD monitor and cause them to fail.
- Certain types of batteries may become hot after an extended period of use. Allow them to cool before unloading them.
- Do not use commercially available batteries that are designed for specific kinds of equipment (such as those marked "For CD players only") in this product.
- When purchasing batteries, read the battery instructions carefully to make sure that they can be used for this product.
- Remove the batteries from the camera before leaving it out of service for long.

- 1 Check that the camera is turned off, and then open the battery cover by pressing the catch and sliding it in the direction shown.

See "Turning on the Camera" (p.41)

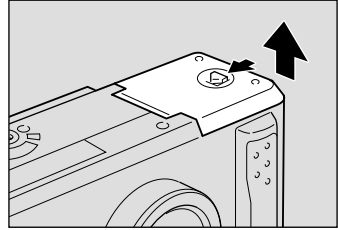

- 2 Load the batteries.



- Make sure that the batteries are loaded with the positive (+) and negative (-) terminals correctly oriented. Do not bring metallic objects, such as a needle, into contact with the battery contact surfaces or electrical connections. Electrostatic damage could result.

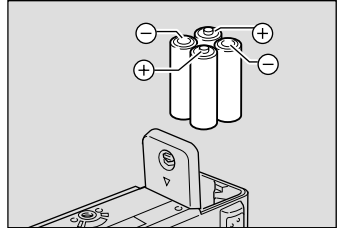

- 3 Close the battery cover

Close the battery cover until it clicks into position.

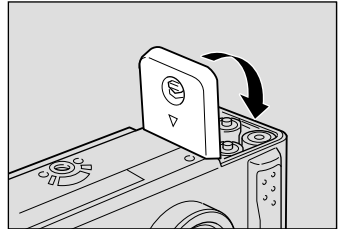

■ Economizing on Batteries

Use of rechargeable Size AA Ni-Cd or AA Ni-MH batteries is recommended for most applications.

If a power source is available nearby, you can economize on the batteries by using an AC adapter (optional).

In shooting pictures, having the LCD monitor display turned off will help your batteries longer-lived.

● Shooting and Playback Guidelines

The table below gives the approximate recording and playback times that are available with Size AA alkaline batteries, as measured under the following test conditions:

[Test conditions]

During shooting: Shoot continuously in a recording mode (shoot at an interval of 30 seconds, without turning off the camera in the middle, with the flash fired 50%, at a 25TM/ambient temperature).

During playback: Leave the camera continuously turned on in a playback mode at a 25TM/room temperature.

Battery type	Approximate Recording Time	Approximate Playback Time
Size AA alkaline batteries	60 minutes	90 minutes
Ni-Cd batteries (1000 mAh)	40 minutes	60 minutes

Tips to Extend the Recording and Playback Times

- * The battery lives indicated above tend to narrow depending on the ambient environment.
- * In an extremely cold environment, warming the batteries by hand, for example, could allow you to take more pictures. Where the ambient temperature is extremely low, use of rechargeable Ni-Cd batteries is recommend for their cold resistance.
- * Choose rechargeable batteries having as high a capacitance as possible. (The capacitance rating is marked in the unit mAh.)
- * Increased use of the flash or zoom feature or the LCD monitor would speed up the exhaustion of the batteries. Cut their usage to a minimum required.
- * The available picture count tends to increase when they are recorded in the 900 × 600 recording mode.
- * Copying or erasing images repeatedly would also accelerate the exhaustion of the batteries.

- Note** • You are advised to make spare batteries available when powering the camera from the internal batteries alone.
- The battery symbol (⎓), when lit, indicates that the camera's internal batteries have a diminishing voltage. Make spare batteries available.
- (Rechargeable Size AA Ni-Cd and Ni-MH batteries have a characteristic tendency to turn off their power immediately when the battery symbol is lit.)

■ Handling Precautions

- Do not use damaged batteries or batteries at the end of their service lives.
- Do not subject the batteries to strong impacts .

Using an AC Adapter

When using the camera for extended periods of time to shoot or playback images, connect an AC adapter (optional) to the camera and power the camera from a household electrical source.

Using the AC Adapter

Before using the AC adapter, be sure to read the safety precautions in the accompanying manual.

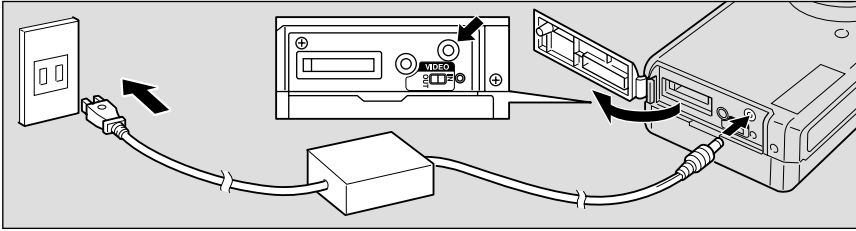

1 Check that the camera is turned off, and then open the terminal cover.

See “Turning on the Camera” (p.41)

2 Connect the AC adapter cable to the power supply terminal (DC input) on the camera.

3 Insert the power plug into the electrical outlet.

Note • If batteries are loaded in the camera while it is connected to a household power source, the camera is powered from the AC source and not by the batteries.

Important Note

- Insert the power plug and connection cable securely. If the plug or cable works loose during recording, the data may be lost or damaged.
- If you connect or disconnect the AC adapter while operating the camera (recording, playback, or erasing), the camera will switch off to determine the power source. This may cause the data to be lost or damaged. To avoid this, connect or disconnect the AC adapter while the camera is turned off.

SmartMedia Memory Cards

This section explains the types and usage of SmartMedia memory cards.

What is a SmartMedia Memory Card?

Files are recorded as data on the SmartMedia memory card in your camera. The following types of SmartMedia memory card can be used:

- Capacity: 2 MB, 4 MB, 8 MB, 16 MB, 32 MB
- Operating voltage: 3.3 V

- Note**
- There are numerous types of SmartMedia memory cards. Before using a commercially available SmartMedia memory card, check with its manufacturer that it is compatible with your camera.
 - By using an optional PC card adapter or floppy disk adapter, you can insert a SmartMedia memory card directly into the PC card slot or floppy disk drive of your PC.

■ Protecting Against Accidental Writing

Attaching a write protect pad to a SmartMedia memory card will prevent accidental erasure or overwriting of recorded files.

Remove the write protect pad from the SmartMedia memory card to record or erase data.

- Note** If the write protect pad gets dirty, wipe it clean with a soft, dry cloth.

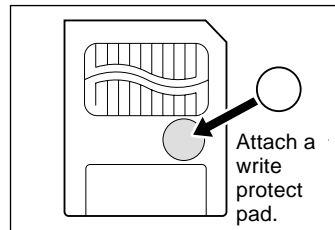

■ Handling Precautions

● SmartMedia Memory Cards

- Never remove the SmartMedia memory card while data is being recorded or erased.
- Do not bend, subject to strong force or shock, or drop the SmartMedia memory card.
- Avoid using or storing SmartMedia memory cards in environments that are subject to static electricity or electrical interference.
- Avoid using or storing SmartMedia memory cards in environments that are subject to high temperature and humidity, where dust accumulates, or in atmospheres where corrosive substances are present.
- Keep the contact surface of the SmartMedia memory card clean and free from dust and foreign matter. Should the contact surface get dirty, wipe it clean with a soft, dry cloth.

- Keep the SmartMedia memory card slot free from dust and foreign matter.
- To avoid possible hazards, keep SmartMedia memory cards away from flames and do not dispose of them in fire.
- SmartMedia memory cards have a limited service life. Cards that have been used over an extended period of time may fail to record additional files.

● Data

- Data recorded on a SmartMedia memory card may be lost by improper handling by the customer or a third party, by being subjected to electricity or electrical interference, or during camera malfunction or repair. Ricoh Co., Ltd. assumes no liability for damages incurred by such loss of recorded data.
- Do not remove the batteries from the camera, turn off the camera, or connect the AC adapter while data is being recorded on the SmartMedia memory card. The data stored on the SmartMedia memory card could be lost or damaged.
- You are advised to copy valuable data from the SmartMedia memory card onto other media, such as floppy disks or hard disks.

Inserting a SmartMedia Memory Card

Check that the camera is turned off before inserting the SmartMedia memory card.



- Never insert or remove a SmartMedia memory card while the camera is turned on.

■ Inserting Card

- 1 Check that the camera is turned off, and then open the card door.

See "Turning on the Camera" (p.41)

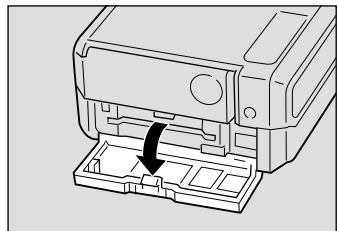

- 2 Insert the SmartMedia memory card into the card insert slot and close the card door.

Push the SmartMedia memory card fully into position, with the contact surface facing up.

Contact surface

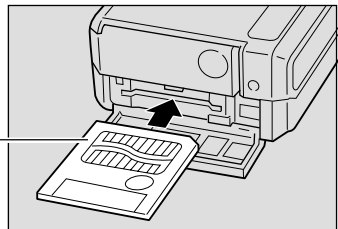



- Insert the SmartMedia memory card in the correct direction. Do not insert it at an angle.
- The camera will not turn on when the card door is open.

■ Removing Card

- 1 Check that the camera is turned off, and then open the card door.



“Turning on the Camera” (p.41)

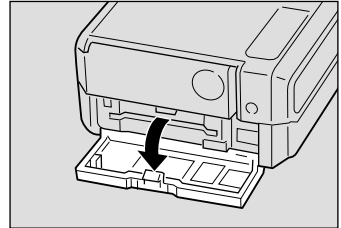

- 2 Press the button and pull the SmartMedia memory card straight out of the slot.

Pressing the button will cause the SmartMedia memory card to pop out a little. Then, pull it straight out of position.

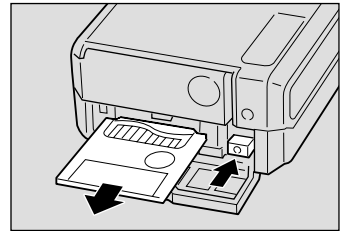

- 3 Close the card door.



- Never remove the SmartMedia memory card while data is being recorded or erased. The data stored on the card could be lost or damaged.
- When the SmartMedia memory card has been removed, place it in the antistatic case supplied or other protective cover.

Formatting a SmartMedia Memory Card

Before using a new SmartMedia memory card or a SmartMedia memory card that has been used on another device (such as a PC), you need to format (initialize) it with the camera.



- Formatting will erase all the files recorded on the SmartMedia memory card (including protected files).
- Do not format SmartMedia memory cards on a PC.
- The SmartMedia formatted by the other device may not be used.

- 1** Insert the SmartMedia memory card and slide the power switch to turn on the camera.

See “Inserting a SmartMedia Memory Card” (p.32)
“Turning On the Camera” (p.41)

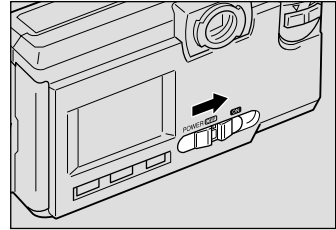

- 2** Set the mode dial to [SETUP].
The setup menu will be displayed.

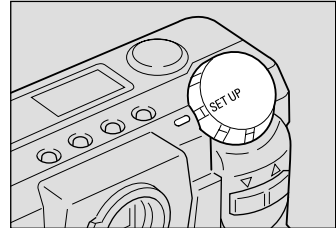

- 3** Press the **▲** or **▼** button to select [FORMAT] and press the ENTER button.

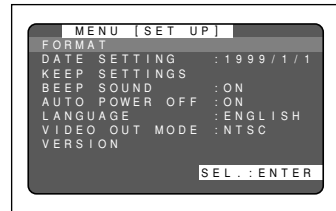

- 4** Press the **▲** or **▼** button to select [FORMAT MEMORY CARD] and press the ENTER button.

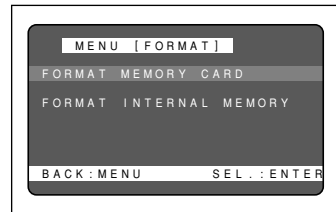

- 5** Press the shutter release button.
The “FORMATTING” message is displayed while the camera is formatting the SmartMedia memory card.

When formatting is completed, the setup menu will reappear. Turn the mode dial to choose another mode.

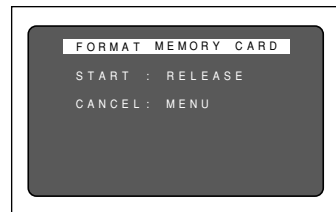

Note • A SmartMedia memory card with a write protect pad attached to it cannot be formatted. Remove the pad to format the SmartMedia memory card.

Before You Start Recording

This section explains the initial camera adjustments and pointers you should know before starting to record pictures.

Setting the Date and Time

The date and time are recorded when you shoot a picture. You will need to adjust these settings when you first use the camera and each time you change time zones on trips.

- Note**
- Use the yy/mm/dd format to set the date.
 - Time is displayed in the 24-hour clock format. Midnight is expressed as 00:00 and noon as 12:00.

1 Slide the center button of power switch to turn on the camera.

- See** "Turning On the Camera" (p.41)

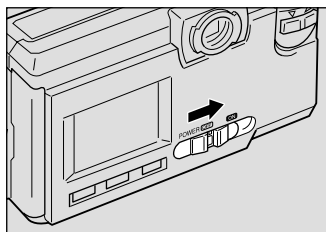

2 Set the mode dial to [SETUP].

The setup menu is displayed.

- Note**
- To cancel the operation, turn the mode dial to another mode.

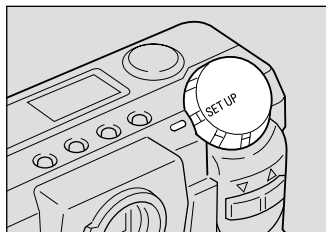

3 Press the **OK** or **DISP** button to select [DATE SETTING].

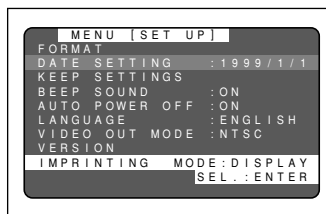

4 Press the DISPLAY button to select the date display method.

There are three methods available to display the date as follows:

1999/5/15 → May 15 1999 → 15 May 1999

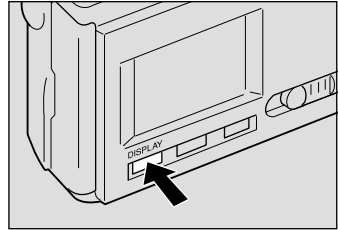

Each time you press the DISPLAY button, the display method is switched from one position to the next in the sequence shown above. Press the DISPLAY button to select the desired date display method.



5 Press the ENTER button.

The date setting menu is displayed.

- Note** • To cancel the operation and return to the setup menu, press the MENU button.

6 Press the  or  button to change the flashing digit.

Forwarding the digit

Press the  button. Keep pressing the button to forward the digit fast.

Reversing the digit

Press the  button. Keep pressing the button to reverse the digit fast.

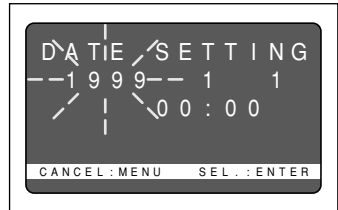

7 Press the ENTER button to flash the digit you want changed.

Repeat steps 6 and 7 above to make necessary corrections.

- Note** • Each time you press the ENTER button, the flashing digit changes, from year to month, day, hour and minute.

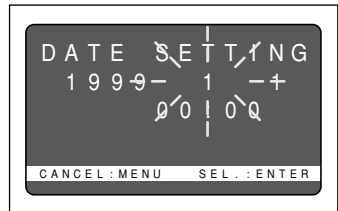

8 After you have set the number of minutes, press the ENTER button again.

The clock gets started and the LCD monitor returns to the SET UP menu. Turn the mode dial to select another mode.

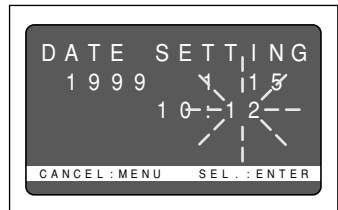



- You can set the time correctly by pressing the ENTER button at the same time as a time signal sounds.
- Press the MENU button in the middle of an operation to cancel it.
- The date and time settings are reset if the battery has been removed for about 3 minutes or longer, as at replacement. Set the date and time again.



How to Verify the Date and Time

Press the ENTER button to view the date and time settings in the LCD monitor for verification. See “LCD Monitor Display Function” (p.50).

Adjusting the LCD Monitor Brightness

You can adjust the brightness setting of the LCD monitor.

- 1 Turn the brightness adjustment dial on the bottom of the camera, left or right to adjust the LCD monitor brightness to a favorable setting for viewing.

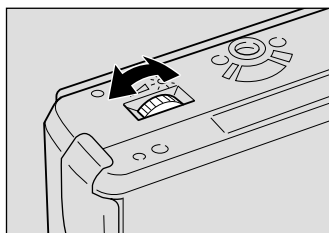

How To Hold the Camera

Unintentional movement of the camera during shooting will result in blurred images. To avoid camera shake, hold the camera in the fashion prescribed below. Be particularly careful to avoid camera shake with telephoto zoom shots.

- 1 Hold the camera steady with both hands with the elbows lightly touching your body.
- When viewing through the viewfinder
With the camera lightly pressed against your head, aim it at your subject and look through the viewfinder.

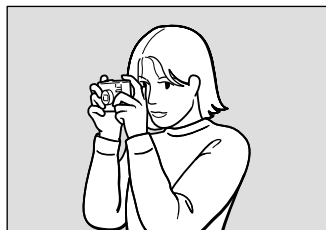

● **When viewing through the LCD monitor**

Hold the camera firmly in both hands, and aim it at your subject and look through the LCD monitor.

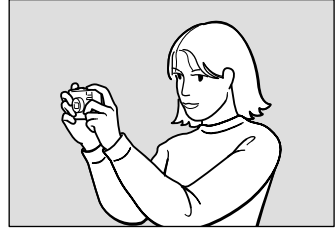

② **Press the shutter release button lightly with your fingertip.**

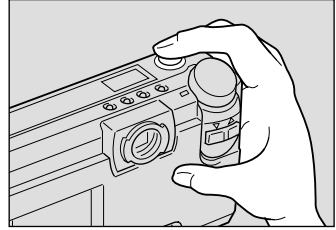

- Pressing the shutter release button at once with the finger initially apart from it could result in a blurred image.



- When an image of a subject that has been shot with the camera held in vertical position is played, the subject will look sideways.

Be careful to keep the camera lens, flash, and the flash sensor reception window from being covered by your fingers or hair.

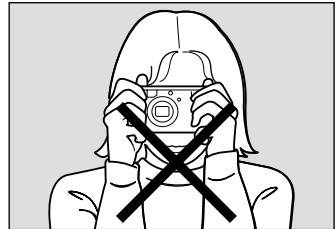

BASIC SHOOTING Chapter

2

Basic Shooting	40
Operation Flow	40
Turning on the Camera	41
Selecting IN/CARD (Internal memory/ SmartMedia memory card) Memory	42
Selecting a PIC (Image quality) Mode	43
Selecting a Recording Mode	44
Setting the Size of the Subject (Zoom)	45
How to View Images on the LCD Monitor	47
Shooting (Still Picture Mode)	48

Basic Shooting

This section explains the general flow of shooting operation, and provides basic shooting instructions.

Operation Flow

To record an image, follow the steps below:

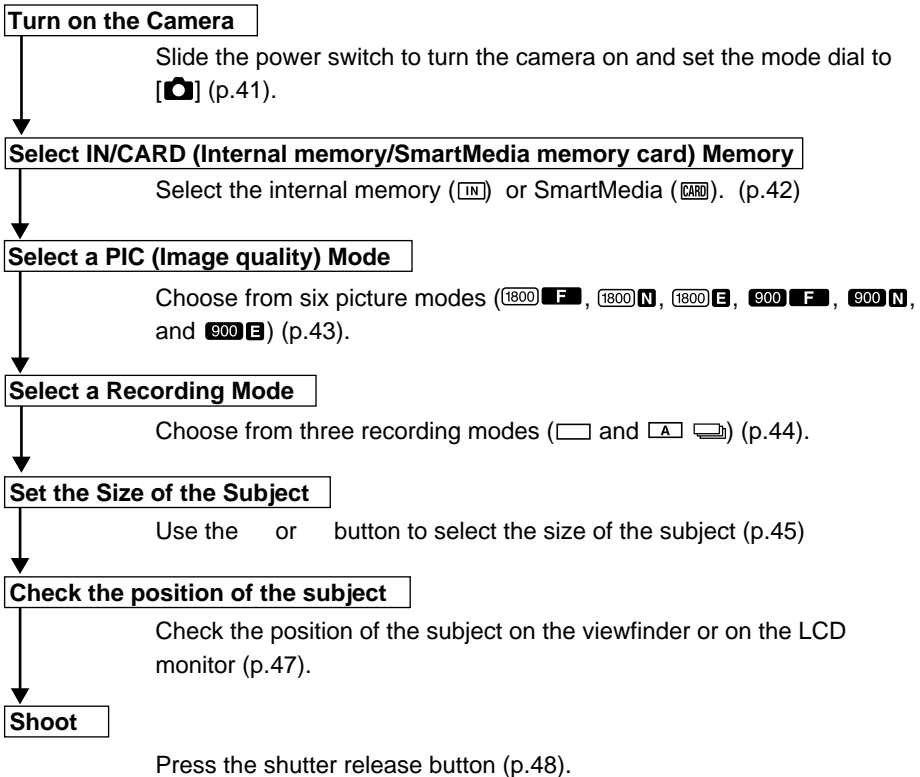

Turning on the Camera

Slide the power switch to turn the camera on and slide the switch again to turn it off.

- 1 Slide the center button of power switch to on.

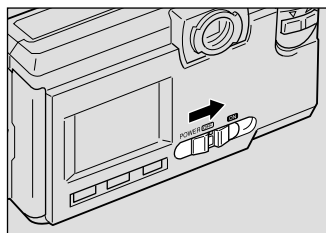

- 2 Set the mode dial to [CAMERA].

The camera will turn on and the monitor cover will open.

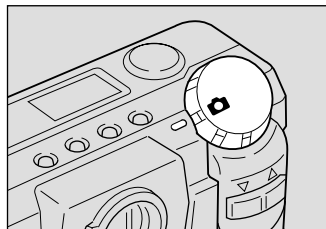

The LCD panel or the LCD monitor will display recording information.

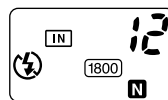

● LCD Monitor Display

Press the DISPLAY button to switch displays appearing on the LCD monitor. If the LCD monitor is not used, press the DISPLAY button to save the batteries. Press the DISPLAY button again to enable the LCD monitor.

You may set the camera to come up with the LCD monitor disabled when it is powered on. See “Changing the LCD Setting” (p.110).

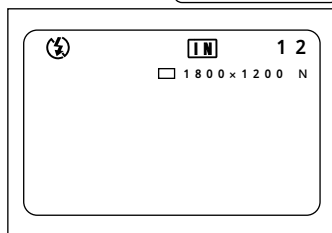

- Slide the power switch again and the power will turn off, with the lens barrier and monitor cover closed. In a play or erase mode, the lens barrier won't open or close when you turn on the power switch.



Auto Power-Off

The camera will turn off automatically (auto power-off) to conserve the battery if it is left idle (no buttons, switches or other controls operated) for more than 5 minutes. To resume use, turn the power on again.

You can disable the auto power-off mode.

See “Auto Power Off Setting” (p.103).

- * The auto power-off mode does not function when the camera is powered by an AC adapter.



- If the keep settings function is enabled, the flash, exposure compensation, white balance, recording mode, date imprint, language, card/in and S mode settings in effect just before the camera was turned off are saved. See “Keep settings” (p.106).

Selecting IN/CARD (Internal memory/SmartMedia memory card) Memory

Select whether to record shot files in internal memory or on the SmartMedia memory card mounted in the camera.

Switching Modes

The mode screen changes in the following sequence as you switch the recording destination:

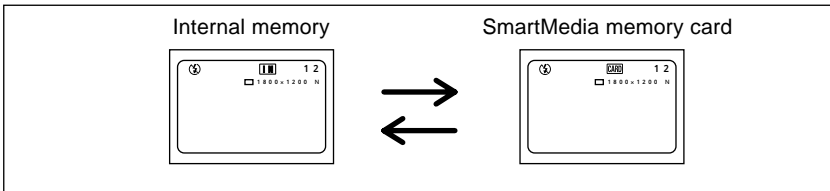

* When the SmartMedia memory card is inserted, the **CARD** will be displayed.

Selecting a Recording Destination

- 1 Press the **CARD/IN** button and select a recording destination (**IN** **CARD**).

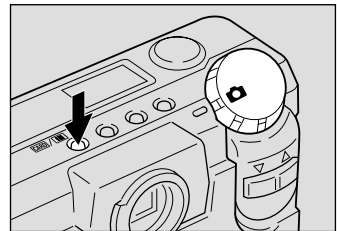

The recording destination changes each time the **CARD/IN** button is pressed. Press the **CARD/IN** button and make your choice.

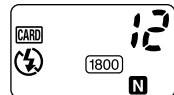

- If a SmartMedia memory card is mounted in the camera when it is turned on, the **CARD** mark appears on the LCD monitor or the LCD panel. Enable the save mode to set internal memory as a recording destination. See “Keep Settings” (p.106).

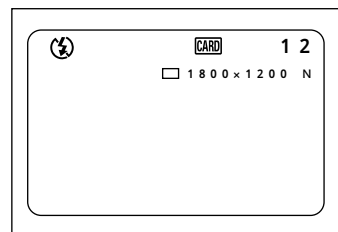

Selecting a PIC (Image quality) Mode

The camera offers six picture (PIC) modes – **1800 F** **1800 N** **1800 E** **900 F** **900 N** and **900 E** – to suit your photographic needs. Each mode has its own compression ratio.

Switching PIC (Image quality) Modes

The mode screen changes in the following sequence as you switch the PIC mode:

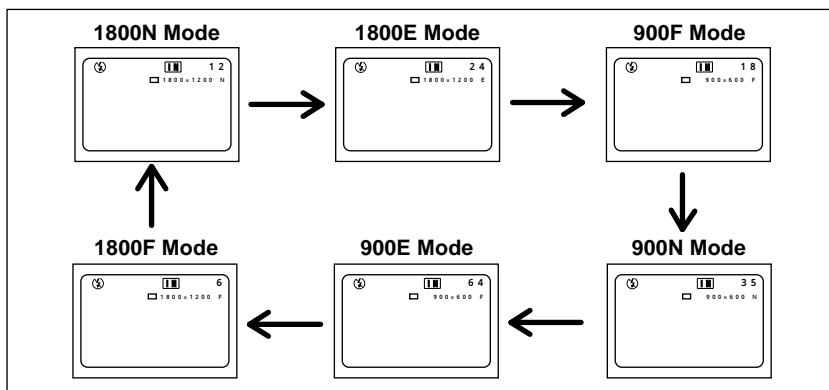

* The recordable picture count varies as you switch the PIC mode.

* The factory default setting is 1800 N (**1800 N**).

Selecting a PIC (Image quality) Mode

- Press the PIC button and select a PIC (Image quality) mode (**1800 F** **1800 N** **1800 E** **900 F** **900 N** **900 E**).

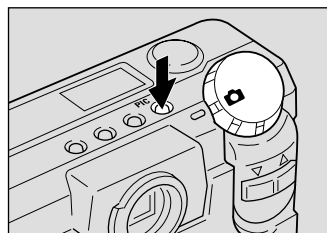

Pressing the PIC button displays the settings menu. The PIC (Image quality) mode changes each time the PIC button is pressed. Press the PIC button and make your choice.

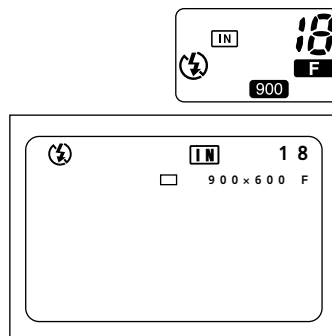

● Approximate File Sizes by PIC (Image quality) Mode

PIC Mode	Approx. File Size	PIC Mode	Approx. File Size
1800F	795 KB	900F	270 KB
1800N	401 KB	900N	139 KB
1800E	204 KB	900E	73 KB

- Note**
- Image sizes are 1792×1200 pixels and 896×600 pixels.
 - The table below shows the maximum number of recordable images associated with each PIC mode.

Size	PIC mode	Approx. No. of recordable images
1792×1200	F mode	9
	N mode	19
	E mode	38
896×600	F mode	29
	N mode	55
	E mode	99

- * In the case of a 8 MB SmartMedia memory card (in each PIC mode)
For the number of recordable images by SmartMedia memory card capacity and by PIC (Image quality) mode, see “Recording Capacities” (p.127).
- * With this product and in this manual, the resolutions are stated as 1800×1200 and 900×600 .

Selecting a Recording Mode

The camera offers three recording modes – still, text and continuous shooting. Select the mode best suited to your photographic needs.

■ Switching Recording Modes

The mode screen changes in the following sequence as you switch the recording mode:

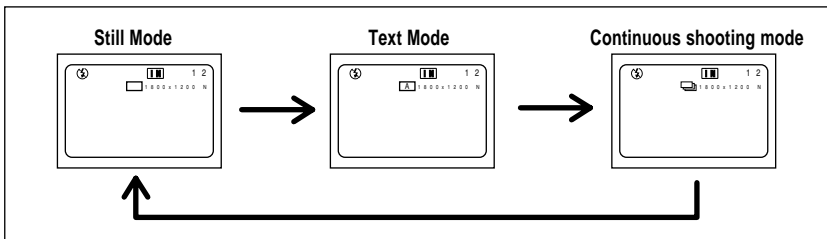

- Note**
- Set Keep Setting to save the recording mode setting.
 - See “Keep Settings” (p.106).

■ Selecting a Recording Mode (for the PIC mode)

This mode is used to record an image.

- 1 Set the mode dial to [📷] and press the MENU button.

The record menu will be displayed.

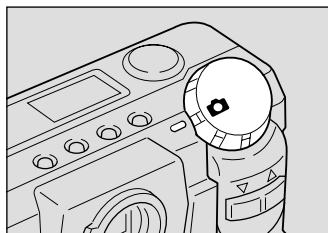

- 2 Press the or button to select [RECORDING MODE].

Note • To cancel an operation, press the MENU button.

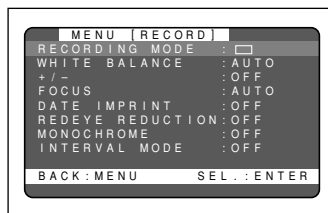

- 3 Press the ENTER button to choose the recording mode (📷).

The recording mode selected will take effect.

Press the MENU button to cancel the recording menu.

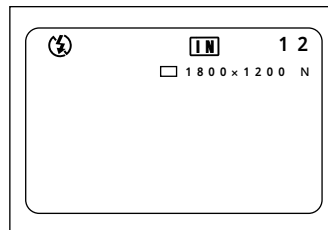

● Other recording modes

Text mode (p.52)

Continuous shooting mode (p.53)

Setting the Size of the Subject (Zoom)

By pressing the or button, you can vary the size of the subject on the LCD monitor without changing the distance between yourself and the subject (equivalent to 38 — 86 mm in 35 mm camera format).

■ Zooming In (Telephoto Setting)

- 1 Press the button.

The subject will become larger (telephoto) and the zoom indication bar will appear on the LCD monitor. Press the button to adjust the subject size to your liking.

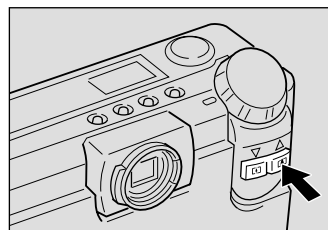

■ Zooming Out (Wide Angle Setting)

① Press the **()** button.

The subject will become smaller (wide) and the zoom indication bar will appear on the LCD monitor. Press the  button to adjust the subject size to your liking.

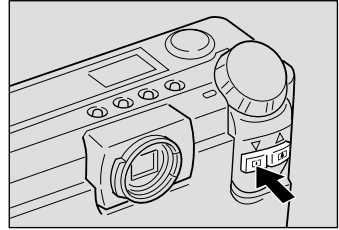

■ Digital Zoom Function

If you keep the **()** button for at least 2 seconds when the lens is set at the maximum telephoto position, the digital zoom function is triggered to add an enhanced telephotographic effect to your shot.

Before using the digital zoom function, make sure that the LCD monitor is On. When the LCD monitor is off, press the DISPLAY button.

When shooting, a frame appears on the LCD monitor as shown on the right, delineating the scope of the digital zoom. At playback, the shot will be played back in the same way as a normal shot.

To disable the digital zoom function, press the **()** button.

Keep the button pressed for 2 seconds or more

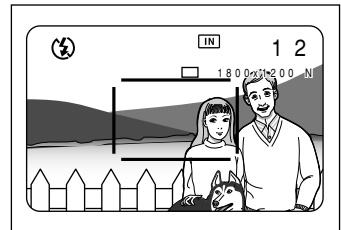
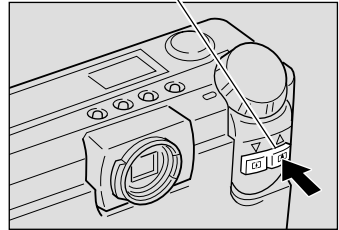

Note

When the digital zoom function is enabled, shots taken will be recorded in 640 × 480 pixel format.

How to View Images on the LCD Monitor

Check the position of your subject by looking through the viewfinder or at the LCD monitor.

■ Viewing Through the Viewfinder

Aim the camera at the subject while viewing through the viewfinder.

● Shooting Scope

Frame the subject within the viewfinder.



● Short-Distance Correction Frame

Compose your subject within this range when the distance to it is about 0.4 m and you are using the standard lens.



● Autofocus Field

Located at the center of the viewfinder screen and roughly corresponding to the area shown on the right, the autofocus field determines the focal distance.

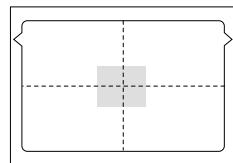

■ Viewing Through the LCD Monitor

Aim the camera at the subject while viewing through the LCD monitor.

● Shooting Scope

Frame the subject within the LCD monitor screen.



● Autofocus Field

Located at the center of the LCD monitor screen and roughly corresponding to the area shown on the right, the autofocus field determines the focal distance.

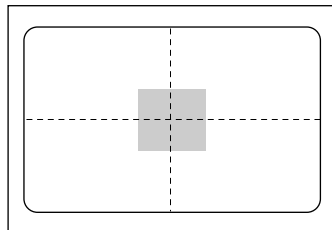

- The shaded area and dotted lines are shown for illustration purposes only and do not actually appear on the LCD monitor.

Shooting (Still Picture Mode)

Basic shooting instructions are given below. Hold the camera correctly to keep it steady.

See “How to Hold the Camera” (p.37)

1 Aim the camera at your subject.

Set the wide angle and use macro mode to shoot subjects closer than 40 cm (15.8 inches).

See “Macro Shooting (Close-up Shooting)” (p.76)

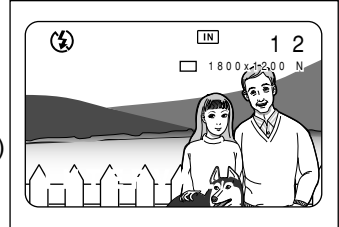

2 Press the or button to set the size of the subject.

See “Setting the Size of the Subject (Zoom)” (p.45)

“How to View Images on the LCD Monitor” (p.47)

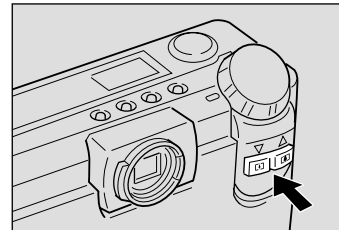

3 Press the shutter release button lightly with your fingertip.

The shutter release button works in a two-step action. When you press it lightly (halfway), the autofocus function is triggered to focus on the subject automatically. Keep the camera as steady as possible during this step to ensure correct focusing.

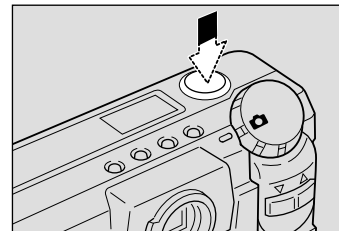

The AF indication LED (green) will light when the subject is in focus. The focus, exposure and white balance settings are set at this point.

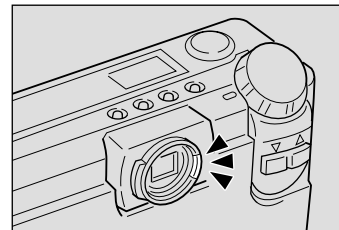

- Note**
- A flashing AF indication LED indicates that the subject is out of focus. If this occurs, use the focus lock function. See “Focus Lock Shooting” (p.68).
 - If the “SLOW SHUTTER” message appears on the LCD monitor, you are recommended to shoot with the flash enabled or in S mode to avoid camera shake that tends to occur in this situation. See “Changing Flash Modes” (p.55) and “S Mode (Shutter Speed)” (p.77).

● Forced, Slow synchro and Auto Flash Modes.

In forced or auto flash mode, the flash LED lights (in red) when you press the shutter release button lightly in low light conditions.

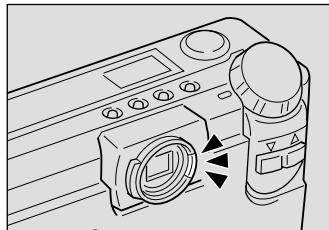



- The flash LED (red) blinks and the LCD monitor is cleared while the flash is charging. Pictures cannot be taken in this state.

④ Press the shutter release button down fully without removing your finger.

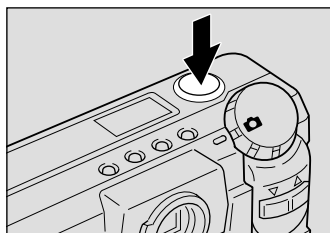
A beep will sound and the picture you have shot appears in the LCD monitor before it is recorded. The available recording picture count in the LCD panel or monitor is then decremented by one.



- Moving the camera before the beep sounds may result in a blurred image.
- The beep will sound continuously if recording fails. Stop recording and reshoot the picture.
- The available recording picture count in the LCD monitor may increase depending on whether you turn on or off the camera, switch the mode dial, or change the PIC mode.
- If it is unnecessary to confirm the picture you have taken, press the  or  button to start recording immediately. You may also change the shot picture confirmation time. See “Changing LCD Confirmation” (p.109).

How to Cancel Recording

When you press down the shutter release button fully, the shot image will appear in the LCD monitor. While the image is on display, you can cancel its recording. do the following:

- Press the MENU button. And press the ENTER button when a recording canceled message is displayed.



Using the Camera for Extended Periods of Time

The camera will switch off automatically (auto power-off) to conserve the battery if it is left idle (no buttons, switches or other controls operated) for about 5 minutes. When you require more time to compose a shot, disable the auto power-off feature. Have spare batteries or an AC adapter handy before using the camera for an extended period of time. See “Auto Power Off Setting” (p.103).

■ When Focusing is Difficult

You may experience difficulty focusing on the following subjects:

- Objects with little or no contrast (such as the sky, white walls, and car hoods)
- Flat two-dimensional objects with only horizontal lines and no significant protrusions or indentations
- Fast-moving targets
- Low-brightness objects (in dark places)
- Strongly backlit objects and objects struck by strong reflected light
- Flickering objects (such as fluorescent lights)

When shooting subjects like these, focus on another subject that is located at about the same distance and then aim at the target with that focus setting.

See “Focus Lock Shooting” (p.68).



LCD Monitor Display Function

Press the ENTER button to display recording information, such as the recording mode, picture mode, and recordable picture count, on the LCD monitor. Each time you press the ENTER button, the display will switch in the following order:

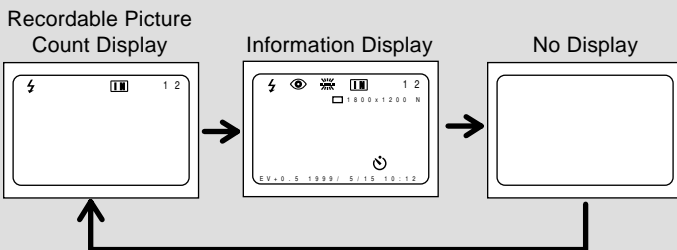

ADVANCED SHOOTING Chapter

3

Changing Recording Modes	52
Text Mode	52
Continuous Shooting Mode	53
Changing Flash Modes	55
Flash Off Mode	56
Auto Mode	57
Forced Flash Mode	58
Slow Synchro Mode	59
Setting the Exposure Compensation	60
Setting the Exposure Compensation	60
Changing the White Balance Mode	62
Daylight Mode	63
Cloudy Mode (Overcast Mode)	64
Tungsten Light Mode	65
Fluorescent Light Mode	66
Special Shooting Functions	67
Using the Self-Timer	67
Focus Lock Shooting	68
Manual Focus Shooting	70
Date Imprinting Mode	71
Redeye Reduction Mode	72
Monochrome Mode (Black & White) Sepia ...	73
Interval (Time lapse) Shooting Mode	74
Macro Shooting (Close-up Shooting)	76
S Mode (Shutter Speed)	77

Changing Recording Modes

This section explains how to change recording modes.

- Note** • For explanations of the recording mode indications appearing on the LCD monitor, see “Selecting a Recording Mode” (p.44).

Text Mode

Records text in a crisp image by accentuating the black portion of the text, with the hues of the surrounding areas being suppressed.

- 1** Set the mode dial to **[📷]** and press the **MENU** button.

The record menu is displayed.

- Note** • To cancel the operation, press the **MENU** button.

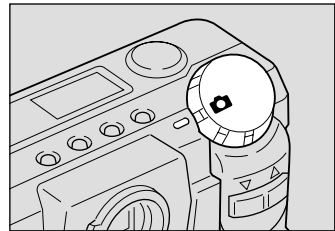

- 2** Press the **or** button to select **[RECORDING MODE]**.

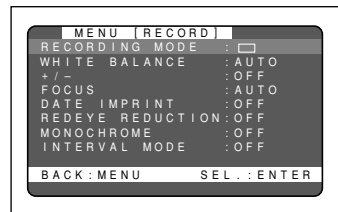

- 3** Press the **ENTER** button to select the **[A]** mark.

Text mode is now set. Press the **MENU** button to close the record menu.

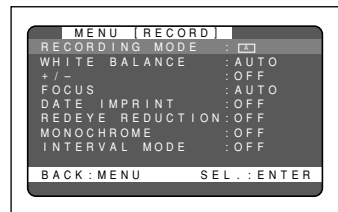

The recording mode setting is displayed on the LCD monitor. Press the shutter release button to shoot the subject.

- Note** • The flash will not fire in text mode.
• Set Keep Setting to save the recording mode setting. See “Keep Settings” (p.106).

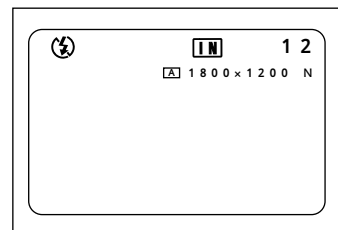

How to Cancel Recording

When you press down the shutter release button fully, the shot image will appear in the LCD monitor. While the image is on display, you can cancel its recording. do the following:

- Press the MENU button. And press the ENTER button when a recording canceled message is displayed.

How To Cancel the Text Mode

Follow the procedures on the previous page and switch to another mode in step ③.

Continuous Shooting Mode

Shoots a subject continuously while the shutter release button is held depressed. The focus is locked in the state in effect when you press the shutter release button and the subject is shot continuously at a rate of about one image a second. This function lets you conveniently capture the beset moment of photography.

- ① Set the mode dial to [📷] and press the MENU button.

The record menu is displayed.

- Note** • To cancel the operation, press the MENU button.

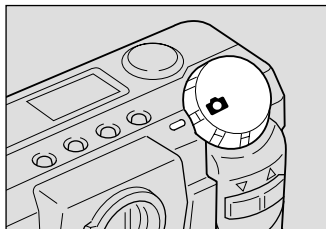

- ② Press the **⏏** or **⏏** button to select [RECORDING MODE].

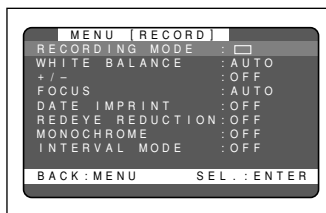

- ③ Press the ENTER button to select the [📷] mark.

The continuous shooting mode is now set.

Press the MENU button to cancel the record menu. (See “Keep Settings” (p.106).)

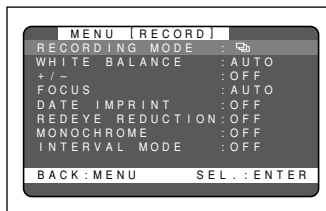

The recording mode setting is displayed on the LCD monitor.

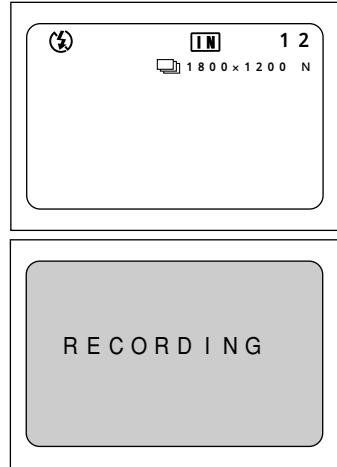

When you continue pressing the shutter release button, the camera will take one picture about every second continuously. Continuous shooting stops when you release the shutter release button, and the images that have been shot so far are recorded automatically. The message “RECORDING” appears on the LCD.



- In Continuous shooting mode, the focus and exposure adjustment level are locked in the status in effect when you press the shutter release button.
- The flash does not fire in continuous shooting mode.



- The maximum number of pictures that can be taken continuously depends on the picture mode.

No. of Pixels	F Mode	N Mode	E Mode
1800 × 1200	2	5	9
900 × 600	7	14	28

- The maximum number of pictures that can be taken continuously at once is indicated above. The available space of the SmartMedia memory card or internal memory may allow continued shooting.
- Continuous shooting stops when as many as 9,999 files have been recorded. In this case, format the SmartMedia memory card or internal memory card to resume continuous shooting.
- In continuous shooting mode, no image appears on the LCD while pictures are being taken.
- Set Keep Setting to save the recording mode setting. See “Keep Settings” (p.106).

Canceling the Mode Setting

In step ③ above, turn the mode dial to choose another mode.

Changing Flash Modes

This section explains how to change the flash mode. Switch the flash mode to meet your photographic needs.

■ Flash Modes

The mode screen will change in the following sequence as you switch the flash mode:

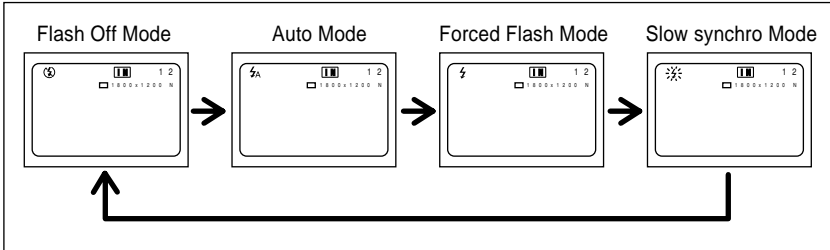

* The factory default setting is flash off mode.



- When you shoot a subject located closer than about 0.4 m (15.8 inches) with the flash activated, the light from the flash may appear red in the resultant shot. The subject may also appear white due to over-exposure. To avoid these problems, switch the camera to flash off mode.



- The flash will not fire in text mode or continuous shooting mode.
- The flash will not fire in the following white balance modes: cloudy (overcast), daylight, fluorescent light, and tungsten light.
- Enable the keep settings mode to save the flash mode setting. See “Keep settings” (p.106).
- When shooting a subject with the flash activated, if the subject appears dark on the LCD monitor, zoom to a wider angle. The subject may be difficult to focus on with the telephoto setting.
- Shooting in red-eye reduction mode will reduce red eyes appearing in the resultant picture. See “Redeye Reduction Mode” (p.72).

Effective Range of the Flash

When you shoot in daylight with the flash activated (daylight synchro photography), the flash has an effective range of about 0.4 to 3.0 m (1.3 ft to 9.9 ft) for the telephoto setting and 0.4 to 3.4 m (1.3 ft to 11.2 ft) for the wide-angle setting. The subject will appear dark in the picture if the light from the flash fails to reach it.

Flash Off Mode

In flash off mode, the flash is disabled even in dark conditions. Use this mode for shooting where use of the flash is prohibited or where adequate room illumination is available.

❶ Set the mode dial to [📷].

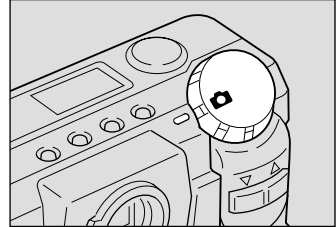

❷ Press the flash mode button to select [📷].

The flash off mode is now set.

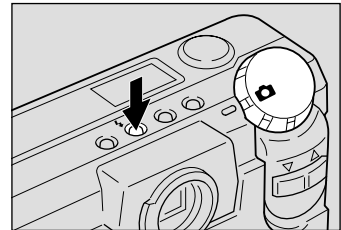

The flash mode setting is displayed on the LCD monitor or on the LCD panel. Press the shutter release button to record the image without firing the flash.

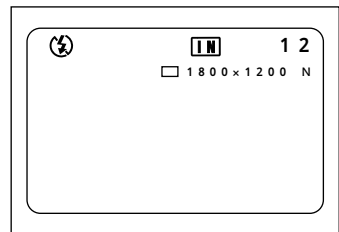
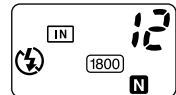

- The shutter speed slows automatically when you shoot in dark places. For best results, hold the camera steady or mount the camera on a tripod. Take extra care in holding the camera steady when using the telephoto setting ([📷]).

How To Cancel the Flash Off Mode

Press the flash mode button and switch to another flash mode.

Auto Mode

This mode automatically discharges the flash when it detects low ambient light or backlighting. This mode allows you to respond appropriately to a wide range of standard shooting conditions.

❶ Set the mode dial to [📷].

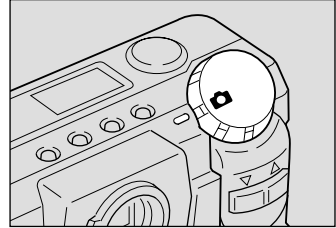

❷ Press the flash mode button to select ζ_A mark.

This auto mode is now set.

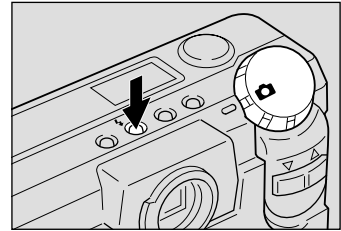

The ζ_A mark, which signifies auto mode, appears only on the LCD monitor. If the mark is not shown in the LCD panel, the camera is in auto mode.

When you press the shutter release button, this mode automatically discharges the flash when the camera detects low ambient light or backlighting. The flash LED will light (red) when you press the shutter release button lightly.

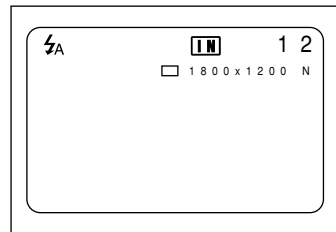
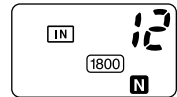

- The flash LED will pulse while the flash is charging and the LCD monitor will momentarily blacken. You will not be able to shoot during this interval.



- Subjects shot from less than 0.4 m (15.8 inches) away may be overexposed and appear bleached out in the picture. To avoid this, switch to the flash off mode.

How to Cancel the Auto Mode

Press the flash mode button and switch to another mode.

Forced Flash Mode

When you take a picture against the light or under strong light, the subject's face may appear in the shade in the resultant shot. Use forced flash mode to reduce this effect. In this mode, the flash will fire regardless of the ambient light level.

❶ Set the mode dial to [📷].

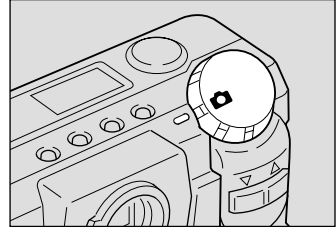

❷ Press the flash mode button to light ⚡ mark.

The forced flash mode is now set.

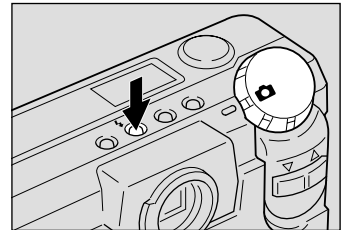

The flash mode setting is displayed on the LCD monitor or on the LCD panel. Press the shutter release button to take the picture using the flash. The flash LED will light (red) when you press the shutter release button lightly.

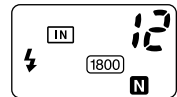

- Note**
- The flash LED blinks and the LCD monitor is cleared while the flash is charging. Pictures cannot be taken in this state.

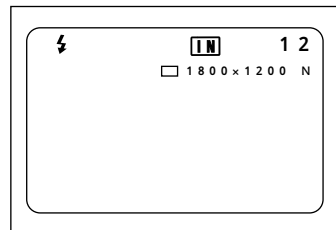

- Important Note**
- When you shoot a subject located closer than about 0.4 m (15.8 inches) with the flash activated, the subject may appear white in the resultant shot due to over-exposure. To avoid this problem, switch to flash off mode.

How To Cancel the Forced Flash Mode

Press the flash mode button and switch to another flash mode.

Slow Synchro Mode

Slows down the shutter release speed when you shoot a subject with the flash activated, to prevent the background alone from being darkened.

❶ Set the mode dial to [📷].

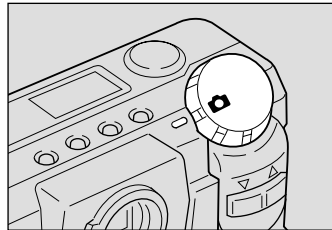

❷ Press the flash mode button to blink the ⚡ mark.

The slow synchro mode is now set.

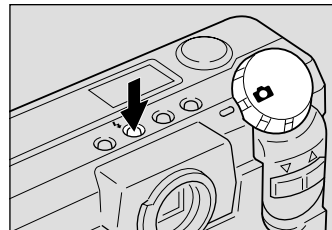

The flash mode setting is displayed on the LCD monitor or on the LCD panel. When you press the shutter release button, the subject is shot in slow synchro mode with the flash activated.

The flash LED lights (red) as you press the shutter release button lightly.

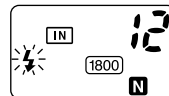

- Note**
- The flash LED blinks and the LCD monitor is cleared while the flash is charging. Pictures cannot be taken in this state.

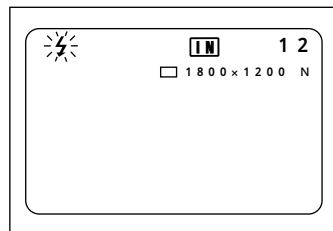

- Important Note**
- When you shoot a subject located closer than about 0.4 m (15.8 inches) with the flash activated, the subject may appear white in the resultant shot due to over-exposure. To avoid this problem, switch to flash off mode.
 - The shutter speed slows automatically when you shoot in dark places. To prevent camera shake, hold the camera steady or mount it on a tripod. Take care to avoid camera shake particularly at [📷] telephoto settings.

How To Cancel Slow Synchro Mode

Press the flash mode button and switch to another flash mode.

Setting the Exposure Compensation

As long as the subject is centered in the shooting range, you can take the picture normally as the camera will automatically adjust the exposure compensation for backlighting. If there is a significant difference in brightness between the background and subject, however, the subject tends to be under- or over-exposed. Exposure compensation is useful in this situation. You can also use exposure compensation to produce intentionally under- or over-exposed images.

● Exposure Compensation Range

±2.0 EV (in 0.5 EV steps)

● Shooting Against the Light

The bright background will make the subject appear under-exposed. Set the exposure compensation level to a positive value to adjust the exposure.



- If the subject is not centered in the shooting range when taking a picture against the light, the camera will not assume that the subject is in a backlit state. Exposure compensation is required in this situation.

● Shooting a White Image

If you shoot an image that appears generally white, the shot will be under-exposed as a whole, with people appearing dark and white objects appearing gray. Set the exposure compensation level to a positive (+) value to adjust the exposure.

● Shooting a Black Image

If you shoot an image that appears generally black, the shot will be over-exposed as a whole, with people appearing white and black objects appearing gray. Set the exposure compensation level to a negative (-) value to adjust the exposure. Follow the same procedure when shooting a person under a spotlight, for example.

Setting the Exposure Compensation

Set the exposure compensation level.

① Set the mode dial to [📷] and press the MENU button.

The record menu will be displayed.



- To cancel the operation, press the MENU button.

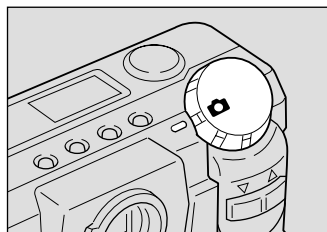

2 Press the \pm or \pm button to select +/- [Exposure Compensation] and press the ENTER button.

The exposure compensation settings menu will be displayed.

Note • To cancel the operation and return to the record menu, press the MENU button.

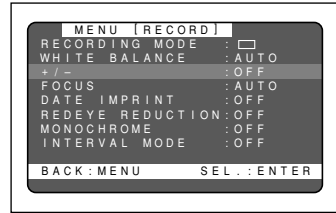

3 Press the zoom button to change the compensation level.

Increasing the Compensation Level in 0.5 EV Steps

Press the (\uparrow) button. Keep pressing the button increases the compensation level fast.

Reducing the Compensation Level in 0.5 EV Steps

Press the (\downarrow) button. Keep pressing the button reduces the compensation level fast.

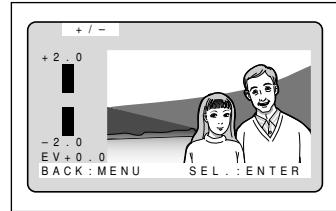

4 Press the shutter release button to shoot the subject.

When you press the shutter release button lightly (halfway), the LCD monitor switches to a normal display. Press down the shutter release button fully to shoot the subject.

When the shooting ends, the setup menu is displayed again on the LCD monitor. To accept the new adjustment level, press the ENTER button; to cancel it, press the MENU button to return to the record menu. Then, press the menu button once again to exit the record menu.

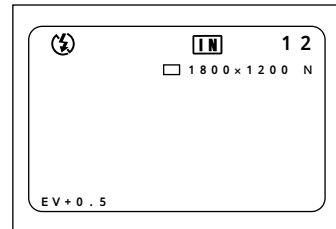

How To Cancel the Exposure Compensation Setting

Follow the above procedures and set the compensation level to [± 0.0] in step 3.

Note • The exposure compensation level setting is canceled when you turn the power switch off. Enable the keep settings mode to save the exposure compensation level setting. See “Keep Settings” (p.106).

Changing the White Balance Mode

The white balance mode adjusts the white balance so that you can capture your subject in its natural colors regardless of the light source. The auto mode will suffice in most situations.

The auto mode automatically adjusts the white balance based on the white areas, ensuring that white is reproduced as white regardless of the light source.

Consequently, a subject that lacks in white tones as a whole or that is dominated by dark tones may not achieve an appropriate white balance. Change the white balance mode to shoot such subjects.

Switching White Balance Modes

The mode screen will change in the following sequence as you switch the white balance mode:

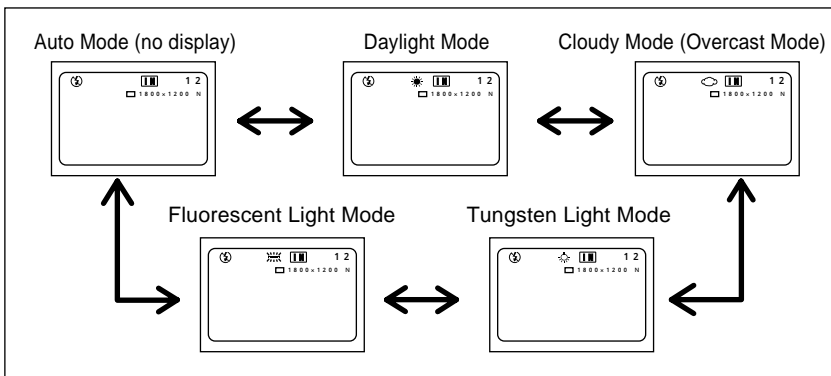

* The factory default setting is auto mode.

Subjects Difficult to Correct in Auto Mode

- Monochrome objects
- Objects lit by multiple light sources

Note

- In auto mode, subjects lacking in white tones may not achieve an appropriate white balance. When shooting such subjects, add a white object to the composition.
- White balance modes can only be set in recording mode and not in playback mode.
- The flash will not fire in the following white balance modes: daylight, fluorescent light, tungsten light and cloudy (overcast) mode.
- Enable the keep settings mode to save the white balance mode setting. See “Keep Settings” (p.106).

■ Displaying the Settings Menu

- 1 Set the mode dial to [📷] and press the **MENU** button.

The record menu will be displayed.

- Note** • To cancel the operation, press the MENU button.

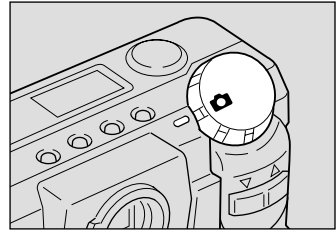

- 2 Press the **⬅** or **➡** button to select [WHITE BALANCE] and press the **ENTER** button.

The white balance settings menu will be displayed.

- Note** • To cancel the operation and return to the record menu, press the MENU button.

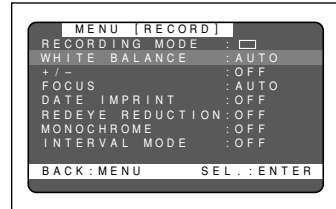

● Switching from One White Balance Mode to Another

You can switch from one white balance mode to another from the settings menu that is displayed. See the following sections concerning each mode.

Daylight Mode (p.63)

Cloudy Mode (Overcast Mode) (p.64)

Fluorescent Light Mode (p.66)

Tungsten Light Mode (p.65)

Daylight Mode

Choose this mode to shoot subjects outdoors that have difficulty achieving auto white balance correction.

- Note** • Select this mode from the white balance mode setup menu. See “Displaying the Settings Menu” (p.63).

- 1 Press the **⬅** or **➡** button to select the **☀** mark.

Daylight mode is now set.

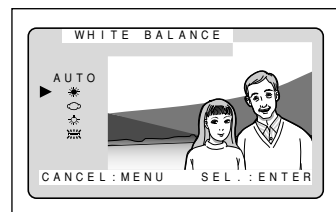

2 Press the shutter release button to shoot the subject.

When you press the shutter release button lightly (halfway), the LCD monitor switches to a normal display. Press down the shutter release button fully to shoot the subject.

When the shooting ends, the setup menu is displayed again on the LCD monitor. To accept the new adjustment level, press the ENTER button; to cancel it, press the MENU button to return to the record menu. Then, press the menu button once again to exit the record menu.

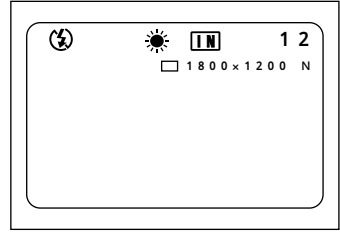

- The color tones of a subject will vary depending on weather conditions, such as fine or cloudy skies.

How To Cancel Daylight Mode

Press the  or  button on the setup menu to switch to auto mode.

Cloudy Mode (Overcast Mode)

Choose this mode to shoot subjects outdoors under cloudy skies where the appropriate white balance is difficult to achieve in auto mode.



- Select this mode from the white balance mode setup menu. See “Displaying the Settings Menu” (p.63).

1 Press the or button to select the mark.

The cloudy mode is now set.

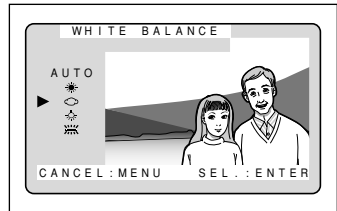

2 Press the shutter release button to shoot the subject.

When you press the shutter release button lightly (halfway), the LCD monitor switches to a normal display. Press down the shutter release button fully to shoot the subject.

When the shooting ends, the setup menu is displayed again on the LCD monitor. To accept the new adjustment level, press the ENTER button; to cancel it, press the MENU button to return to the record menu. Then, press the menu button once again to exit the record menu.

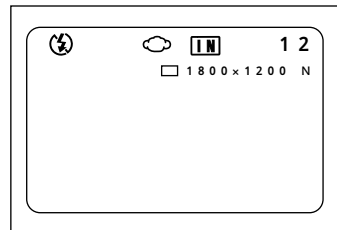



- The color tones of a subject will vary depending on weather conditions, such as fine or cloudy skies.

How To Cancel the Cloudy (Overcast) Mode

Press the or button to select [AUTO] in the setup menu.

Tungsten Light Mode

Choose this mode to shoot subjects under tungsten light where an appropriate white balance is difficult to achieve.



- Select this mode from the white balance mode settings menu. See “Displaying the Settings Menu” (p.63).

- 1 Press the or button to select the mark.

The tungsten light mode is now set.

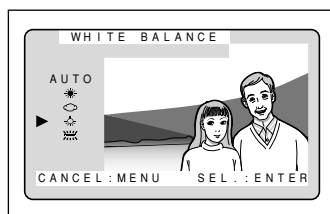

- 2 Press the shutter release button to shoot the subject.

When you press the shutter release button lightly (halfway), the LCD monitor switches to a normal display. Press down the shutter release button fully to shoot the subject.

When the shooting ends, the setup menu is displayed again on the LCD monitor. To accept the new adjustment level, press the ENTER button; to cancel it, press the MENU button to return to the record menu. Then, press the menu button once again to exit the record menu.

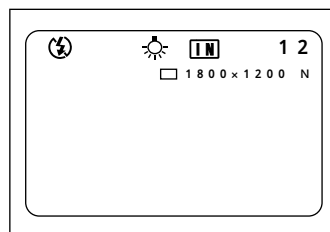

- The color tones of a subject will vary depending on the type of light source (tungsten light).



How To Cancel the Tungsten Light Mode

Press the or button on the setup menu to switch to auto mode.

Fluorescent Light Mode

Choose this mode to shoot subjects under fluorescent light where an appropriate white balance is difficult to achieve.

- Note** • Select this mode from the white balance mode settings menu. See “Displaying the Settings Menu” (p.63).

1 Press the  or  button to select the  mark.

The fluorescent light mode is now set.

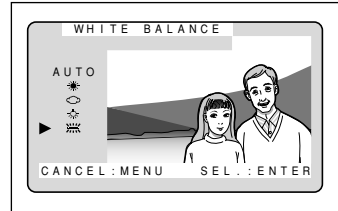

2 Press the shutter release button to shoot the subject.

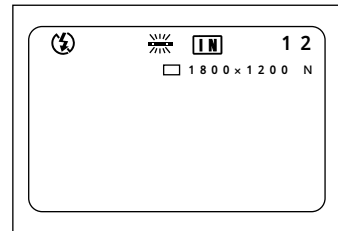

When you press the shutter release button lightly (halfway), the LCD monitor switches to a normal display. Press down the shutter release button fully to shoot the subject.

When the shooting ends, the setup menu is displayed again on the LCD monitor. To accept the new adjustment level, press the ENTER button; to cancel it, press the MENU button to return to the record menu. Then, press the menu button once again to exit the record menu.



- Important Note** • The color tones of a subject will vary depending on the type of light source (fluorescent light).

How To Cancel the Fluorescent Light Mode

Press the  or  button on the setup menu to switch to auto mode.

Special Shooting Functions

This digital camera offers a variety of shooting techniques in addition to basic photography.

Using the Self-Timer

The self-timer offers a convenient way to take group pictures with the photographer included. Mount the camera on a tripod or a flat, secure surface to shoot pictures with the self-timer.

- 1 **Set the mode dial to [📷] and press the self timer button.**

The self timer is now set.

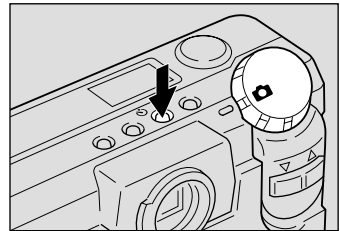

The self timer will be displayed on the LCD monitor or on the LCD panel.

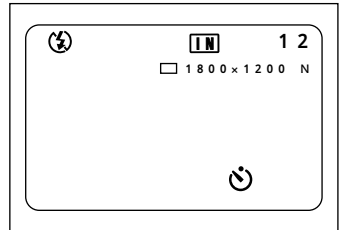
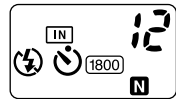

- 2 **Decide the composition of the picture, position the camera securely, and press the shutter release button.**

The self timer LED will start flashing and the shutter will be released with an approximate delay of 10 seconds. The self timer LED will stay lit for about 2 seconds before the shutter is released and the beep sound will be heard.

The self-timer mode ends automatically when the shutter is released.

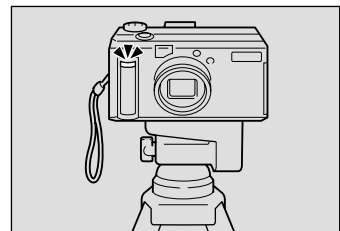

Note

- If the flash is charging, the self-timer will start when charging is completed.
- The self-timer setting is canceled when you switch the camera from the recording mode to another mode or when you slide the power switch.

Tips

Remote Control

To operate the camera from a remote position or when the camera is fixed in one spot, use the optional remote control unit.

Focus Lock Shooting

Usually, the auto focus function focuses the camera on the subject that appears in the autofocus field on the LCD monitor or on the viewfinder. If the subject is located outside the autofocus field, it may appear blurred in the resultant shot. Use the focus lock to ensure accurate focusing on the subject.

See

“How to View Images on the LCD Monitor” (p.47)

■ When to Use the Focus Lock

If the subject is not positioned inside the autofocus field on the LCD monitor, a blurred image will result, since the background, not the subject, is in focus.

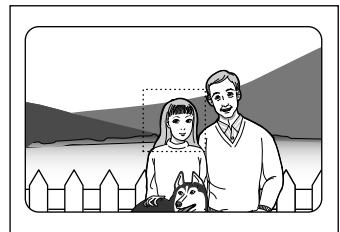

If an object other than the subject occupies a major portion of the autofocus field, the camera will focus on the background, producing a blurred image of the persons.

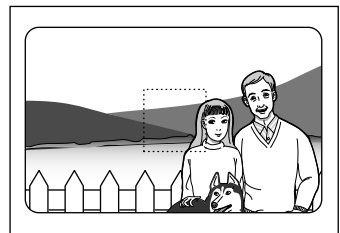

■ How to Use the Focus Lock

- 1 Press the ([↑]) or ([↓]) button to set the size of your subject.

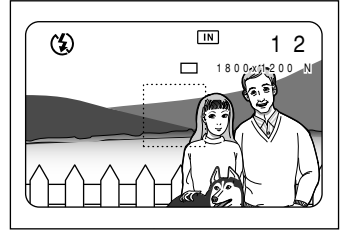

- 2 Bring the subject on which you wish to focus into the autofocus field.

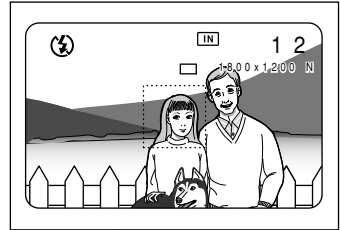

- 3 Press the shutter release button lightly and hold it.

The focus will be locked at this point.
The focus lamp (green) will light.

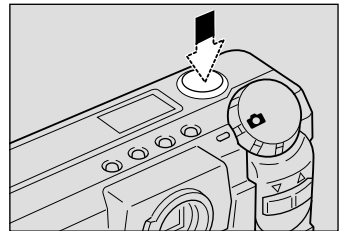

- 4 Decide the composition of the shot by moving the camera with the shutter release button held, and then press the shutter release button down fully.

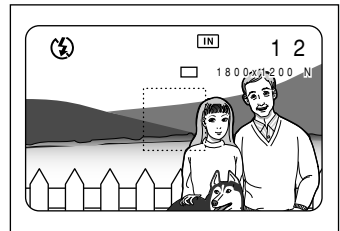

Note

- You can also use the manual focus to focus on the subject. See “Manual Focus Shooting” (p.70).

Manual Focus Shooting

The manual focus function can be used to manually adjust the focal setting for subjects difficult to bring into focus with autofocus.

- 1 Set the mode dial to [📷] and press the **MENU** button.

The record menu will be displayed.

- Note** • To cancel the operation, press the MENU button.

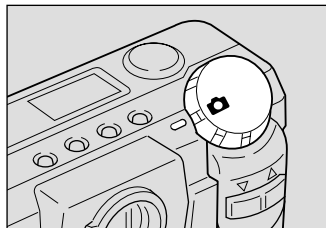

- 2 Press the **←** or **→** button to select [FOCUS].

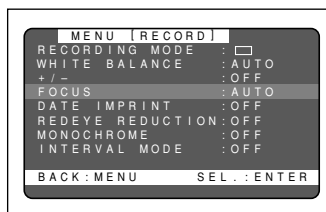

- 3 Press the **ENTER** button to select [MF] and press the **MENU** button.

The manual focus function is now set.

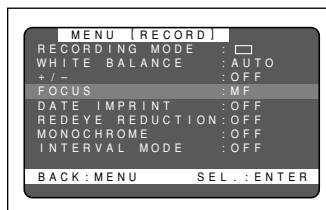

- 4 Press the **←** or **→** button to focus on the subject and press the shutter release button to take the picture.

To vary the size of the subject on the LCD monitor, press the **(↑)** or **(↓)** button with the shutter release button lightly pressed.

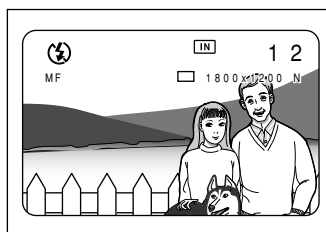

How To Cancel the Manual Focus Mode

Follow the above procedures and select [AF] in step 3.

Date Imprinting Mode

Use this mode to record images imprinted with the date.

- Note** • The date is displayed in the format that has been selected with the DATE SETTING option in the setup menu. See “Setting the Date and Time” (p.35).

1 Set the mode dial to [📷] and press the MENU button.

The record menu is displayed.

- Note** • To cancel the operation, press the MENU button.

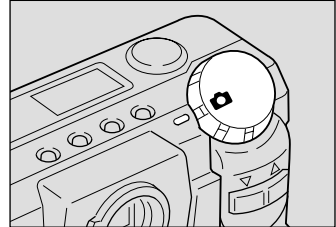

2 Press the \leftarrow or \rightarrow button to select [DATE IMPRINT].

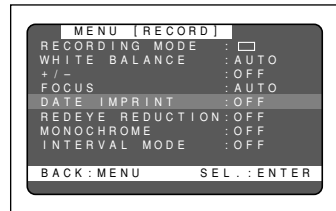

3 Press the ENTER button to select between [DATE] and [DATE/TIME]. And then press the MENU button.

The date (1999/5/15) is displayed if you have chosen [DATE], or the date and time (1999/5/15 10:12) is displayed if you have chosen [DATE/TIME].

Date imprint mode is now set.

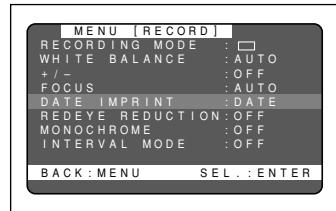

4 Press the shutter release button to shoot the subject.

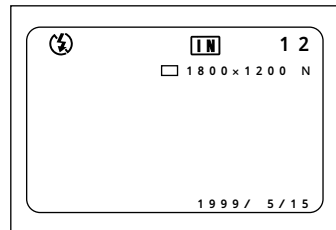

How To Cancel Date Imprinting Mode

Follow the above procedures and select [OFF] in step 3.

- Note** • Enable the save mode to save the date imprinting mode setting. See “Keep Settings” (p.106).

Redeye Reduction Mode

If you shoot a subject, with the flash activated, in a dark place, the eyes of the subject may appear red in the resultant picture. In redeye reduction mode, the flash will fire several times before the shutter releases to lessen the redeye phenomenon.

- 1 Set the mode dial to [📷] and press the **MENU** button.

The record menu is displayed.

- Note** • To cancel the operation, press the MENU button.

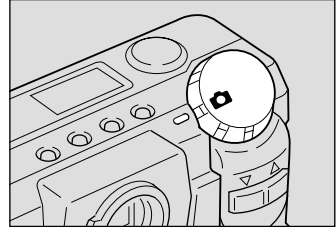

- 2 Press the **⏏** or **⏏** button to select “REDEYE REDUCTION”.

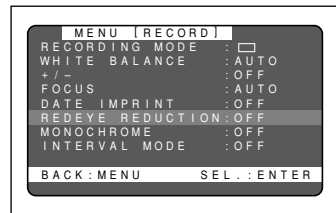

- 3 Press the **ENTER** button to select [ON] and press the **MENU** button.

The redeye reduction mode is now set.

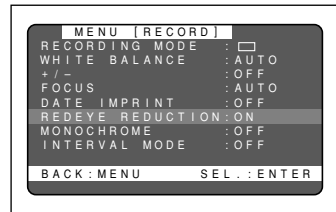

- 4 Press the shutter release button to shoot the subject.

When you press the shutter release button, the flash will fire several times in succession preliminarily before firing last when the shutter releases.

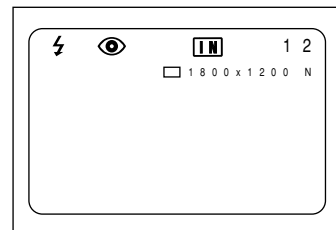
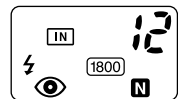



- The shutter takes about 1 second to release after you press the shutter release button. Hold the camera steady meanwhile to shoot.

How To Cancel Red-eye Reduction Mode

Follow the procedures on the previous page and select [OFF] in step 3.

Monochrome Mode (Black & White) Sepia

Shoots subjects in black & white or sepia images.

- 1 Set the mode dial to [📷] and press the MENU button.

The record menu is displayed.



- To cancel the operation, press the MENU button.

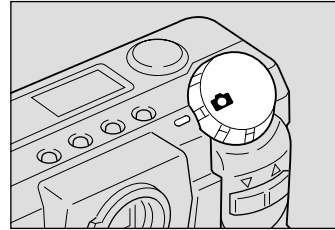

- 2 Press the **or** button to select [MONOCHROME].

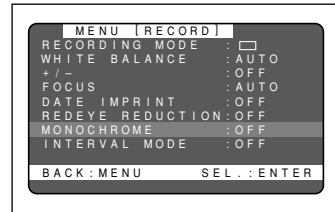

- 3 Press the ENTER button to select between [B&W] and [SEPIA] and press the MENU button.

Select [B&W] to shoot in black & white images or [SEPIA] to shoot in sepia images. The monochrome mode is now set.

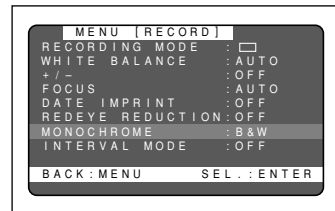

- 4 Press the shutter release button to shoot the subject.



- When you choose monochrome mode, the white balance mode does not function.

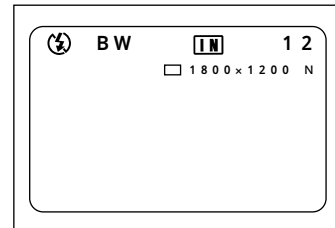

How To Cancel Monotone Mode

Follow the above procedures and select [OFF] in step 3.

Interval (Time lapse) Shooting Mode

The camera can be set to take pictures automatically at preset times. The times can be set in steps of 30 seconds from 30 seconds to 3 hours. For example, if you set a time of 1 hour, the camera will release the shutter every hour, taking pictures continuously until the SmartMedia memory card runs out of available memory.



- Check the remaining number of pictures that can be stored on the SmartMedia memory card and the internal memory card before starting interval (time lapse) shooting. The auto power off will be activated after 24 hours.

1 Set the mode dial to [📷] and press the MENU button.

The record menu will be displayed.



- To cancel the operation, press the MENU button.

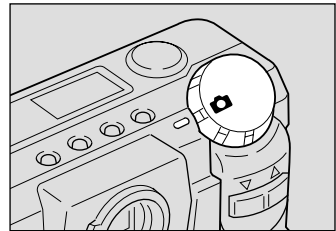

2 Press the **or** button to select [INTERVAL MODE] and press the ENTER button.

The interval timer (time lapse) settings menu will be displayed.



- To cancel the operation, press the MENU button. The screen returns to record menu.

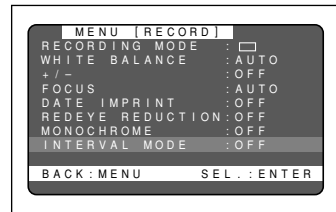

3 Press the ENTER button until the digit you want to set starts to flash.



- Each time you press the ENTER button, the flashing digit will change, from the hour to the minute to the second.

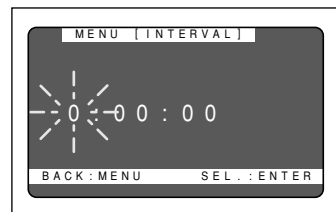

- 4 Press the **or** button to change the value of the digit that is flashing.

Repeat steps 3 and 4 above to set the desired interval in steps of 30 seconds.

Increasing the Values

Press the **(\blacktriangle)** button. Keep pressing the button increases the values quickly.

Decreasing the Values

Press the **(\blacktriangledown)** button. Keep pressing the button decreases the values quickly.

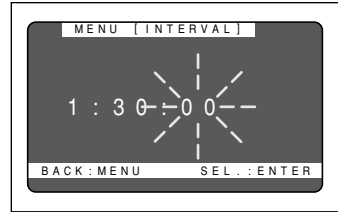

- 5 Press the **ENTER** button again after setting the digit of second.

The interval timer (time lapse) function is now enabled and the record menu is displayed.

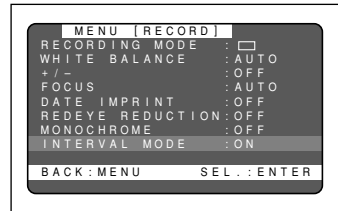

- 6 Press the **MENU** button.

The record menu will close and exit to the normal display, and the "INTERVAL" message will appear on the LCD monitor.

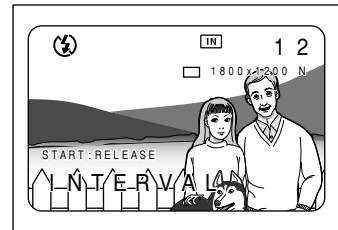

- 7 Press the **shutter release** button.

The camera will take the first shot and then proceed to shoot at the preset time. The "INTERVAL" message flashes on the LCD monitor while interval (time lapse) shooting is in progress. Interval (time lapse) shooting will last until the internal memory or SmartMedia memory card runs out of available memory.

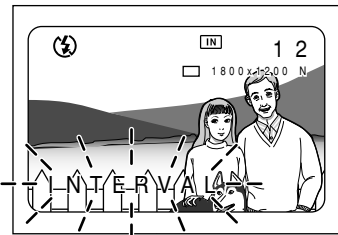

Note

- The actual time between shots may become longer than the preset value depending on the PIC (Image quality) and flash mode settings.
- Use of an AC adapter to power the camera is recommended for interval (time lapse) shooting.

How To Cancel Interval Shooting

If the "INTERVAL" message lights up on the LCD monitor, take the following procedures:

- Follow the procedures on the previous page and set the interval (time lapse) timer to [0:00:00].
- Slide the power switch off.
- Set the mode dial to switch to another mode.

How To Cancel Shooting

The "INTERVAL" message flashes on the LCD monitor while interval (time lapse) shooting is in progress. To cancel shooting while in progress, take the following procedures:

- Slide the power switch off.
- Set the mode dial to switch to another mode.

Macro Shooting (Close-up Shooting)

Macro photography allows you to take a closeup picture of a subject. Macro photography up to about 4 cm close is made possible by setting the lens to the widest angle position. With the lens set at an other position, macro photography as close as about 40 cm is possible.

- 1 Set the mode dial to [📷].

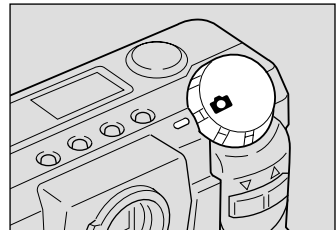

- 2 Bring the camera close to the subject and decide the composition of the picture. Press the shutter release lightly to set the focus.

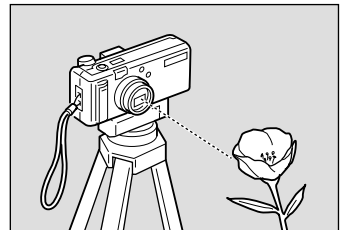

- 3 Gently press the shutter release button down fully to take the picture.



- The focusing range is so small in macro mode that the focus can be lost if the camera is moved. Make sure the camera is firmly positioned by mounting it on a tripod, for example, to keep it steady when shooting.
- Light from the flash may appear red in shots taken in flash mode. The subject may also appear white in the resultant shot due to over-exposure.
- Since the field of view through the viewfinder and the shooting range are shifted by a wide margin, take pictures by confirming the shooting range through the LCD or with the camera connected to a TV receiver.



Focal Range for Macro Shooting

Use macro mode for subjects located about 4 cm (1.6 inches) to 40 cm (15.8 inches) away.

Shutter Release Button

The optional remote control unit is convenient to use when the camera is mounted on a tripod or similar device and the shutter release button is difficult to press.



- Pictures take in S mode may occasionally have some noise.

S Mode (Shutter Speed)

S mode, the shutter is released faster to make low light shots possible. If the "SLOW SHUTTER" message appears on the LCD monitor when you point the camera at a dark subject and press the shutter release button lightly, S mode will help reduce camera shake that tends to occur in this situation.



- Pictures taken in S mode may occasionally have some noise.

1 Set the mode dial to [📷] and press the MENU button.

The record menu will be displayed.



- To cancel the operation, press the MENU button.

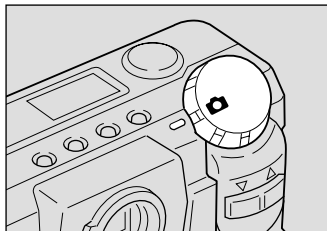

2 Press the **or** button to select [S MODE].

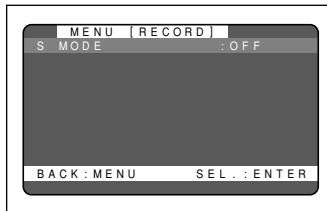

3 Press the ENTER button to select [ON] and press the MENU button.

The S mode is now set.

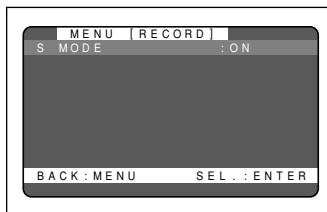

4 Press the shutter release button to take the picture.

The camera will automatically determine whether to shoot in S mode or not according to the brightness of the subject. If the "SLOW SHUTTER" message appears on the LCD monitor when you press the shutter release button lightly, the shot will be taken in S mode.

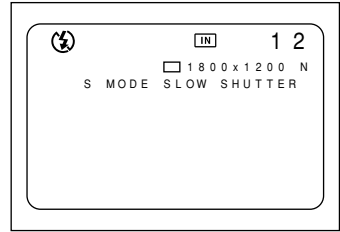

- Note** • Moving the camera before the beep sounds, after pressing the shutter release button, could result in a blurred image.

How To Cancel the S Mode

Follow the above procedures and select [OFF] in step 3.

- Note** • S mode works only when the flash is disabled from firing.
• Enable the keep settings to save the S mode setting. See "Keep Settings" (p.106).

PLAYBACK/ERASING Chapter

4

Before Starting To Playback Recorded Images ...	80
Playback Display	80
Connecting to a TV	81
Playing Back a File	82
Operation Flow	82
Playing an Image File	83
Multi Image Playback	84
Zoom Playback	85
Auto Playback	86
Protecting a File	87
Playing a File Shot with Another Brand of Camera	88
Copying Image Files	89
Setting DPOF (Direct Print of File)	91
Setting a Printing Service	91
Erasing a File (Image)	94
Operation Flow	94
Erase	95
Erase All Images	96
Erase Selected Files (Images)	97



Before Starting to Playback Recorded Images

This section explains the preparations for playing back recorded images and how to read the playback display.

Playback Display

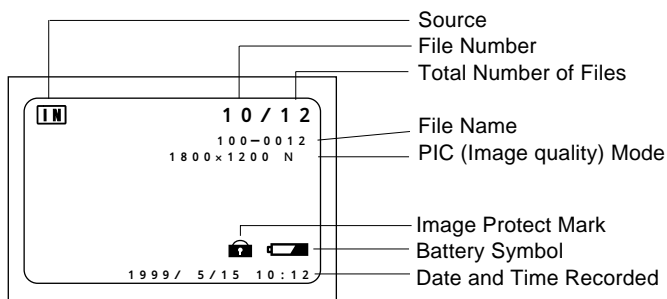
Information about a recorded file, including its number and type, will be displayed for about 2 seconds when you select PLAY mode.



Source	Internal memory or SmartMedia memory card	
		Internal memory
		SmartMedia
File Number	Number of the file being played	
Total Number of Files	Total number of files recorded	
File name	Name of the file being played. For use when the file is submitted to digital printing services or other applications. When a file that does not conform to the DCF (Design rule for Camera File system) image file format is played, "□□□□□□□□" will appear. *File names changed on a PC may not be displayed correctly on the camera.	
PIC Mode	Displays the PIC mode of the file being played.	
Image Protect Mark	Indicates that a protected file is being played.	
Battery Mark	Displays the status of exhaustion of the battery loaded in the camera.	
Date and Time Recorded	Displays the date and time at which the file was recorded.	

- Note** • Recorded images are played back assuming that the camera was held horizontally to shoot them. Accordingly, pictures shot with the camera held vertically will be displayed sideways.

Tips

LCD Monitor Display Function

Press the ENTER button to display information, such as the date and time recorded, on the LCD monitor. Each time you press the ENTER button, the display will change in the following sequence:

Selected File Number/
Total File Count

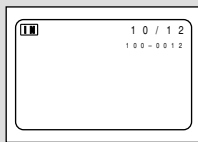

All Information

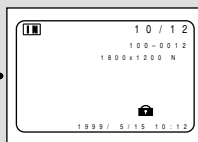

No Display

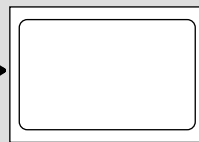

Connecting to a TV

Connect the camera to a TV set with the video interface cable supplied to play recorded image files on the TV screen. You may also connect the cable to a VCR to record your images on videotapes.

Important Note

- Please refer to the instruction manual for the equipment to which the camera is connected.

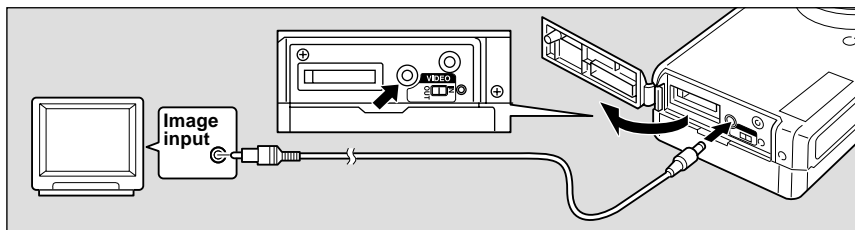

- 1 Check that both the camera and the TV are turned off.
- 2 Open the camera's terminal cover and connect the video interface cable to the video in/out terminal.
- 3 Connect the other end of the video interface cable to the Video In terminal on the TV.

Using the Camera for Extended Periods of Time

Supplying power to the camera from a household AC outlet using an optional AC adapter is recommended for shooting over extended periods of time. See "Using an AC Adapter" (p.29).

- Make sure that the camera is turned off before connecting the AC adapter.

Note

- When you are away on overseas trips, you may view recorded image on a PAL TV set. See "Changing Video-out Signal Method (NTSC/PAL)" (p.105).
- You may use this camera as a monitor for a video printer or other video gear (NTSC only). Set the video I/O switch to [IN] and connect the video cable to the video output terminal of the video gear. The LCD monitor would appear blank when the video cable is connected to video gear after the video I/O switch is changed to PAL.
- The LCD monitor would appear blank if you connect the video interface cable to the camera when its video I/O switch is set to PAL.

Playing Back a File

This section provides instructions for playing back recorded image files.

Operation Flow

To play back an image file, follow the steps below:

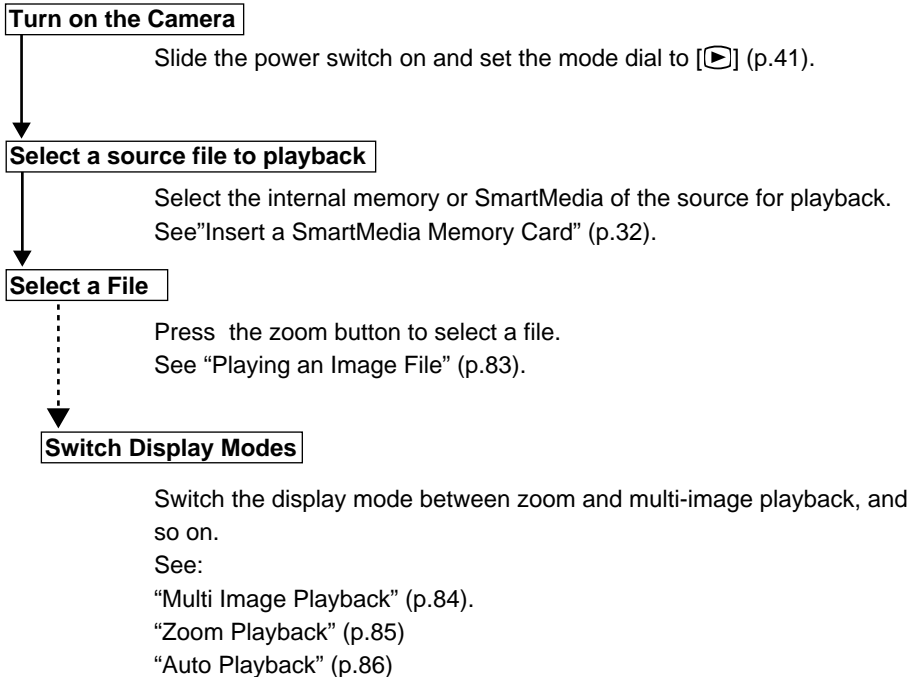

■ Files That Can Be Played on the Camera

The following kinds of files can be played on this camera:

- Files recorded on this camera
- Files transferred from a PC using software compatible with this camera
- Files shot with another brand of camera

See "Playing a File Shot with Another Brand of Camera" (p.88)



- The "UNMATCHED FILE" message will be displayed if an unplayable file is encountered.
- Data recorded on the Ricoh RDC-300Z/RDC-4300, 4200 digital camera can also be displayed (but Multi Image Playback, zoom playback, sound file or NC file playback is not possible).

Playing an Image File

Follow the procedure below to play files recorded in still picture text mode or continuous shooting mode.

1 Set the mode dial to [▶].

The most recently recorded file is played back on the LCD monitor.

See “Playback Display” (p.80)

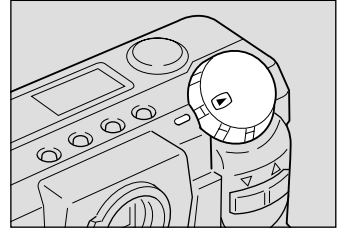

2 Press the CARD/IN button to select the source for playback.

3 Press the or button to select the file to be played back.

Cycle forward

Press the ([▶]) button.

Cycle backward

Press the ([◀]) button.

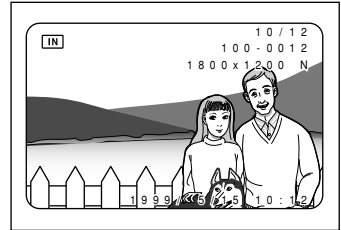

● Playback Display

If pictures are taken in the following image sizes, their playback displays will appear as shown below.

1800 × 1200

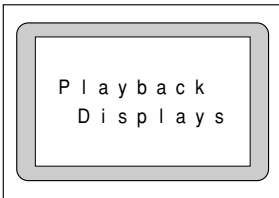

900 × 600

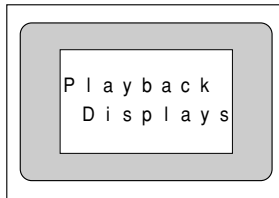

640 × 480

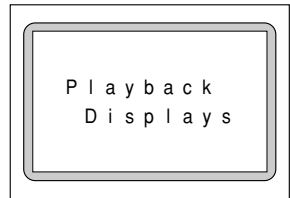

Note

- Files may take long to play after the camera is turned on or the mode dial is set, depending on the capacity of the SmartMedia memory card mounted.
- Files that have been recorded in continuous shooting mode are recorded as a single file and therefore can be played the same way as regular files.
- You can view six images in a single LCD monitor screen at a time. See “Multi Image Playback” (p.84).
- You can view image files magnified. See “Zoom Playback” (p.85).
- You can let the camera play image files automatically. See “Auto Playback” (p.86).
- You can protect files from being erased. See “Protecting a File” (p.87).

Multi Image Playback

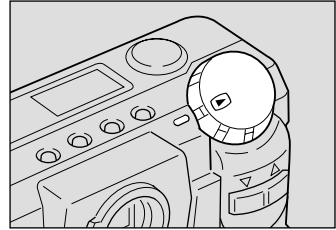

Multi-image playback lets you view six images at once on the LCD monitor for quick searching.

- 1 Set the mode dial to [▶].

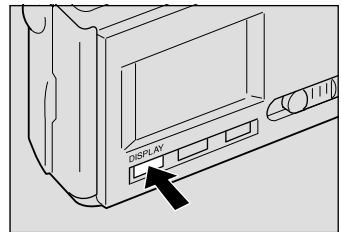

- 2 Press the DISPLAY button.
The multi-image playback function is now set.





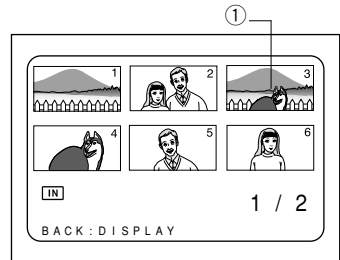

- 3 Press the  or  button to select the file to be played back.

The LCD monitor displays six files at a time, with the position in which each file is displayed determined by the file number. The file, whose file number is reversed, is the selected file.



Moving the Selected File

Press the  button to advance to later files; press the  button to return to earlier files.

- Note**
- Unplayable files recorded on other equipment will be displayed on a blue background.
 - Press the  button while the cursor is on the last (lower right) file, will display the next set of six files: press the  button while the cursor is on the first (upper left) file will display the previous set of six files.

- 4 Press the DISPLAY button.
The normal screen will be displayed. And the file of the reversed number will be displayed in the single-image mode.

Zoom Playback

An image file that is played is displayed twice the height and width of the original.

- Note** • Only images recorded in sizes of 1800 × 1200 (F/N/E) and 900 × 600 (F/N/E) can be played zoomed.

1 Set the mode dial to [▶] and press the MENU button.

The play menu will be displayed.

- Note** • To cancel the operation, press the MENU button.

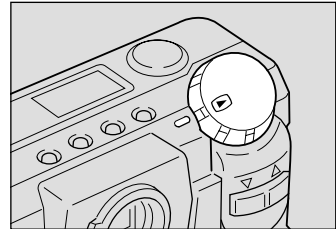

2 Press the [ZOOM PLAYBACK] button or the [ENTER] button to select [ZOOM PLAYBACK] and press the ENTER button.

- Note** • To cancel the operation, press the MENU button. The screen returns to play menu.

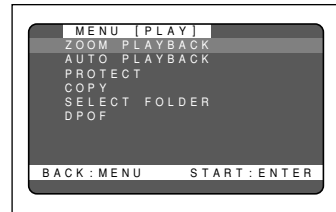

- See** See “Playing an Image File” (p.83)

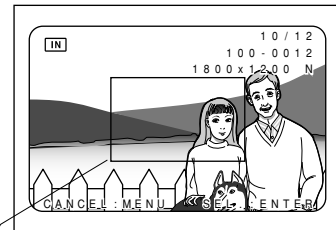

The central part of the playback screen zooms in.

The file is then displayed in an magnified image.

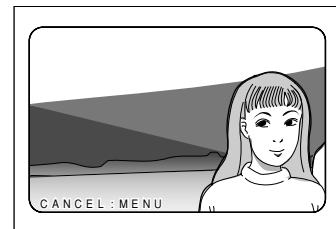

3 Press the [ZOOM PLAYBACK] button or the [ENTER] button to verify the image file.

Press the [ZOOM PLAYBACK] button to shift the playback position as shown by the solid line in the illustration shown on the next page; press the [ENTER] button to shift the playback position as shown on the next page by the dotted line.

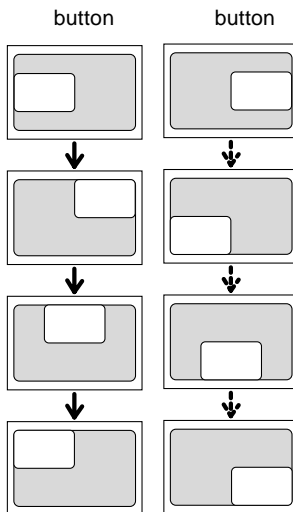
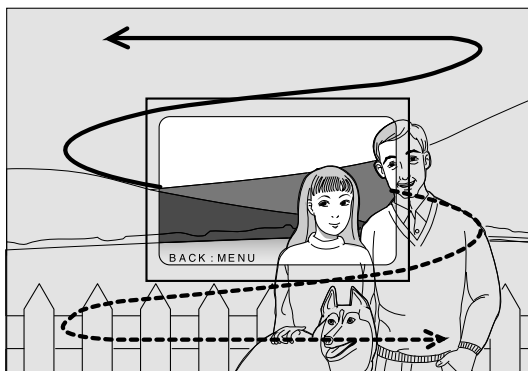

- 4 After confirming the image file, press the MENU button to cancel the zoom playback mode. The play menu will be displayed.**

Press the MENU button again to cancel the operation.

Auto Playback

This function automatically plays all the files stored in internal memory or on the SmartMedia memory card.

- 1 Set the mode dial to [▶] and press the MENU button.**

The play menu will be displayed.

Note • To cancel the operation, press the MENU button.

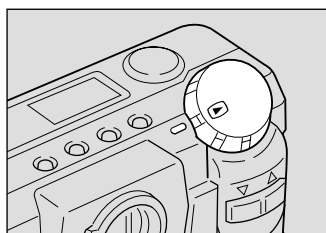

- 2 Press the or button to select [AUTO PLAYBACK] and press the ENTER button.**

The auto playback setup menu is displayed.

Note • To cancel the operation and return to the play menu, press the MENU button.

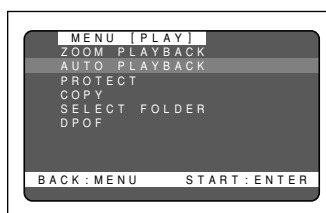

- Press the **▲** or **▶** button to select the interval at which the image files are played and press the **ENTER** button.

You can choose the auto playback interval from among 1 SEC., 5 SEC., 10 SEC., and 30 SEC. Press the enter button to start playing files automatically at the specified time interval. Playback will continue until you cancel it.

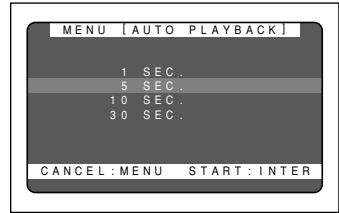

How To Cancel Auto Playback

Press any button, such as the shutter release button or zoom button, to cancel an auto playback in progress.

Protecting a File

You can protect valuable files from being erased accidentally.



- Formatting the SmartMedia memory card will erase protected, as well as unprotected, files.

- Set the mode dial to **[▶]** and press the **MENU** button.

The play menu will be displayed.



- To cancel the operation, press the **MENU** button.

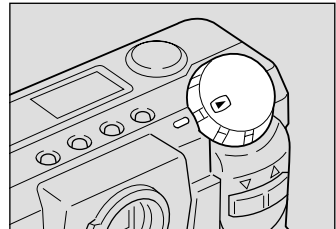

- Press the **▲** or **▶** button to select **[PROTECT]** and press the **ENTER** button.

The protection settings menu will be displayed.



- To cancel the operation and return to the play menu, press the **MENU** button.

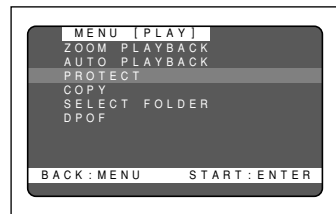

- Press the **▲** or **▶** button to select the file you wish to protect and press the **ENTER** button.

The selected file will be protected and the **🔒** mark will be displayed. If you keep the setting, repeat step **3**.

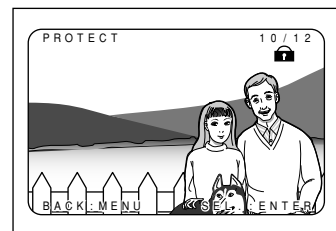

4 Press the MENU button to cancel the protect setting.

The screen returns to the play menu. Press the MENU button again to cancel the operation.



- Protected files cannot be erased until the protection setting is cancelled.
- Files displayed in multi-image playback mode cannot be protected. Switch to a single-image mode to carry out protection setting. See “Multi Image Playback” (p.84).

How To Cancel the Setting

Choose a protected file in step 3 above and press the enter button to erase the mark.

Playing a File Shot with Another Brand of Camera

Files recorded with a non-Ricoh camera can be played if the non-Ricoh camera conforms to the DCF (*1) image file format.

*1 DCF is short for "Design rule for Camera File system)," which is a set of specifications standardized by the Japan Electronic Industry Development Association (JEIDA).

1 Mount a SmartMedia memory card in the camera.



See “Inserting a SmartMedia Memory Card” (p.32).

2 Set the mode dial to [▶] and press the MENU button.

The play menu is displayed.



- To cancel the operation, press the MENU button.

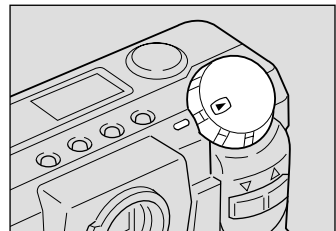

3 Press the or button to select [SELECT FOLDER] and press the ENTER button.

The folder selection setup menu is displayed.



- To cancel the operation and return to the play menu, press the MENU button.

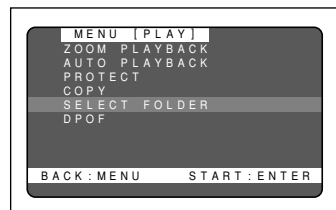

- 4 Press the **or** button to select a folder and press the **ENTER** button.

The play menu is displayed again. Then, press the **MENU** button once again to close the play menu.

The image files in the folder are displayed. Press the **or** button to select files to play.

See See “Playing an Image File” (p.83).

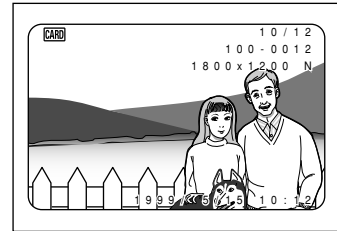
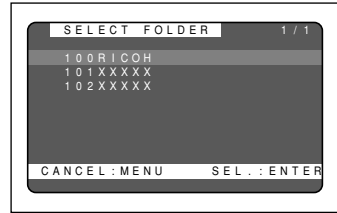

Copying Image Files

Copies image files from internal memory to the SmartMedia memory card or vice versa.

- Note**
- When a protected image is copied, the source image is unprotected.
 - Only the pictures that have been taken with this camera can be protected.

- 1 Set the mode dial to **[▶]**.
- 2 Press the **CARD/IN** button to select where to copy from and press the **MENU** button.

The play menu is displayed.

- Note**
- To cancel the operation, press the **MENU** button.

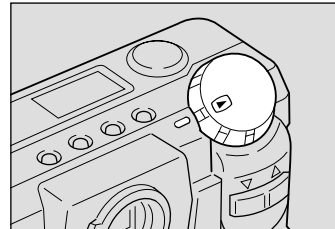

- 3 Press the **or** button to select **[COPY]** and press the **ENTER** button.

The image copy setup menu is displayed. If you have been playing files from the SmartMedia memory card, select **CARD → IN**; if you have been playing files from internal memory, select **IN → CARD**.

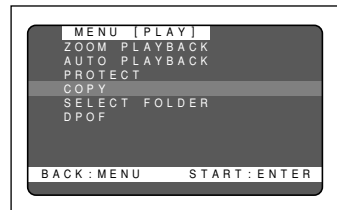

● Copy modes

See:

- “Copying All Images in a batch” (p.90)
- “Copying Selected Image” (p.90)

■ Copying All Images in a Batch

- 1 Press the **○** or **□** button to select [ALL] and press the ENTER button.

The all copy menu is displayed.

- Note**
- To cancel the operation and return to the play menu, press the MENU button.

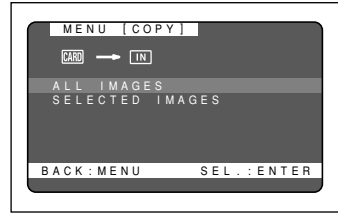

- 2 Press the shutter release button.

All the image files are copied in a batch. When the copying is complete, press the MENU button to exit the operation.



Important Note

- If enough space is not available at the destination, the message "INSUFFICIENT MEMORY" is displayed. Press the shutter release button to copy as many images as are permitted by the available memory space. Press the MENU button to cancel the copy operation.

■ Copying Selected Image

- 1 Press the **○** or **□** button to select [SELECT] and press the ENTER button.

The select copy menu is displayed.

- Note**
- To cancel the operation and return to the play menu, press the MENU button.

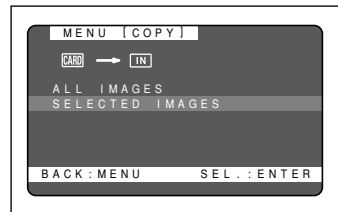

- 2 Press the **○** or **□** button to select the file to copy and press the ENTER button.

The C mark is displayed in the image file thus selected. To copy more files, repeat steps 1 and 2 as many times as needed.

- Note**
- To cancel copying a file bearing the C mark, press the ENTER key again.

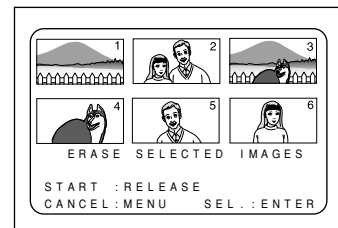

3 Press the MENU button to end the copying.

The play menu is displayed again. Then, press the MENU button once again to exit the operation.



- If enough space is not available at the destination, the message “INSUFFICIENT MEMORY” is displayed. Press the shutter release button to copy as many images as are supported by the available memory space. Press the MENU button to cancel the copy operation.

Setting DPOF (Direct Print of File)

DPOF is a special feature built into your camera that allows you to assign information to your images for use by digital printing services, desktop printers that accept memory cards or devices that allow direct to print from your camera. By assigning DPOF information to an image, you may designate the quantity of images you wish to have printed or have an index of selected images printed directly from the memory card or image file.

When submitting recorded images to digital printing services or other applications, set the number of copies of the images to print and that of copies of the index. This setting is possible only when you select the RICOH folder.

Setting a Printing Service

Be sure to leave a free space of memory for one or two images in the SmartMedia memory card for which the printing service is set.

Once a printing service is set, never program record, erase or any other settings. If any setting is programmed, reprogram it.

1 Set the mode dial to [▶] and press the MENU button.

The play menu will be displayed.



- To cancel the operation, press the MENU button.

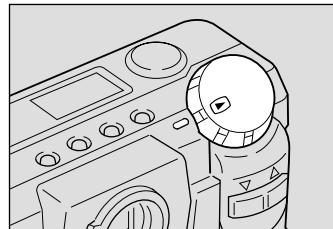

2 Press the or button to select [DPOF] and press the ENTER button.

The DPOF setup menu will be displayed.



- To cancel the operation and return to the play menu, press the MENU button.

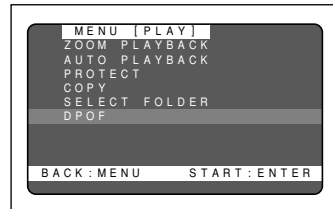

3 Press the shutter release button.

If DPOF has been set with your camera, press the shutter release button to clear the DPOF setting. You won't be able to set a print service unless the DPOF setting is cleared.

● Canceling copy count specifications and settings

Specifying an Image Print Copy Count (p.92)

Specifying an Index Print Copy Count (p.92)

How to Cancel the DPOF Settings (p.93)



■ Specifying an Image Print Copy Count

- 1 Press the **or** button to select [STANDARD PRINT] and press the **ENTER** button.

The LCD monitor changes to a six-image display.

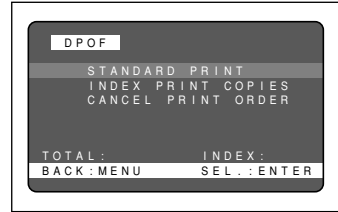

- 2 Press the **or** button to select the image for which to specify a print copy count and press the **ENTER** button.

The image file having the image number reversed is displayed in a single display screen.

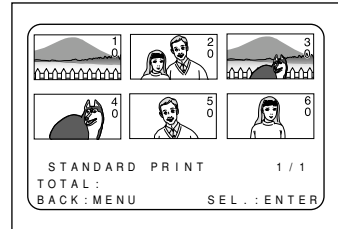

- 3 Press the **or** button to specify a print copy count and press the **MENU** button.

The print copy count is set and the LCD monitor returns to the six-image display. To set more print copy counts, repeat steps 2 and 3 as many times as needed.

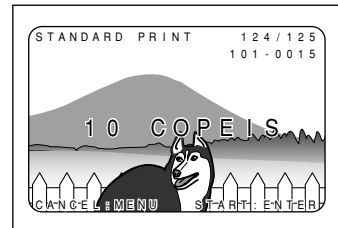

- 4 Press the **MENU** button to exit the print copy count setting.

Turning the mode dial with this screen on display will clear the setting. Be sure to exit to the play menu.

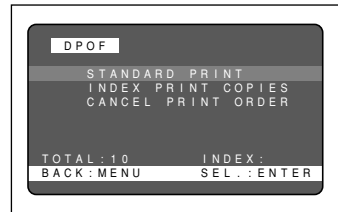

How To Cancel the Setting

Follow the above procedures and set a print copy count of 0 in step 3.

- Note** • Choose [CANCEL PRINT ORDER] to cancel all the settings. See “How To Cancel the DPOF Settings” (p.93).

■ Specifying an Index Print Copy Count

The index print feature allows all the images stored in the RICOH folder to print on a reduced scale. You can use the index print feature to list the images recorded in the folder for visual confirmation or to specify an index for specifying a print count.

- 1 Press the **or** button to select [INDEX PRINT COPIES] and press the **ENTER** button.

An index print copy count setup menu is displayed.

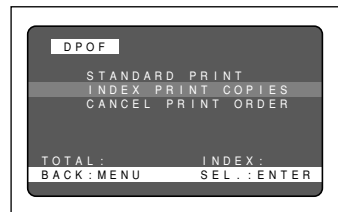

Note • To cancel the operation and return to the play menu, press the MENU button.

- 2 Press the **or** button to specify an index print copy count and press the **ENTER** button.

The index print copy count is set.



- 3 Press the **MENU** button to exit the index print copy count setting.

Turning the mode dial with this screen on display will clear the setting. Be sure to exit to the play menu.

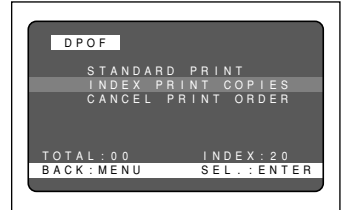

How To Cancel the Setting

Follow the above procedures and set a index print copy count of 0 in step 2.

Note • Choose [CANCEL PRINT ORDER] to cancel all the settings. See “How To Cancel the DPOF Settings” (p.93).

■ How To Cancel the DPOF Settings

- 1 Press the **or** button to select [CANCEL PRINT ORDER] and press the **ENTER** button.

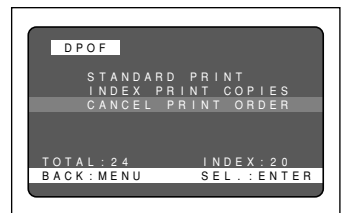

- 2 Press the **shutter release** button.

All the DPOF settings are cleared.

- 3 Press the **MENU** button to exit the **CANCEL PRINT ORDER** operation.

Turning the mode dial with this screen on display will clear the setting. Be sure to exit to the play menu.



Erasing a File (Image)

This section explains how to erase recorded files. There are three ways to erase files:

- (1) erase, one selected file is erased at a time
- (2) erase all, all files are erased at once, and
- (3) format, files on a SmartMedia memory card that have been used on another device are erased and the card is formatted for use with this camera.



- Files on a write-protected SmartMedia memory card cannot be erased unless the write protect pad is removed from the card. See “Protecting Against Accidental Writing” (p.31).
Only the pictures that have been taken with this camera can be erased.
- Depending on the SmartMedia capacity, it may take a short time to erase a file after turning on the power or changing the mode dial.

Operation Flow

To erase image files, follow the steps below:

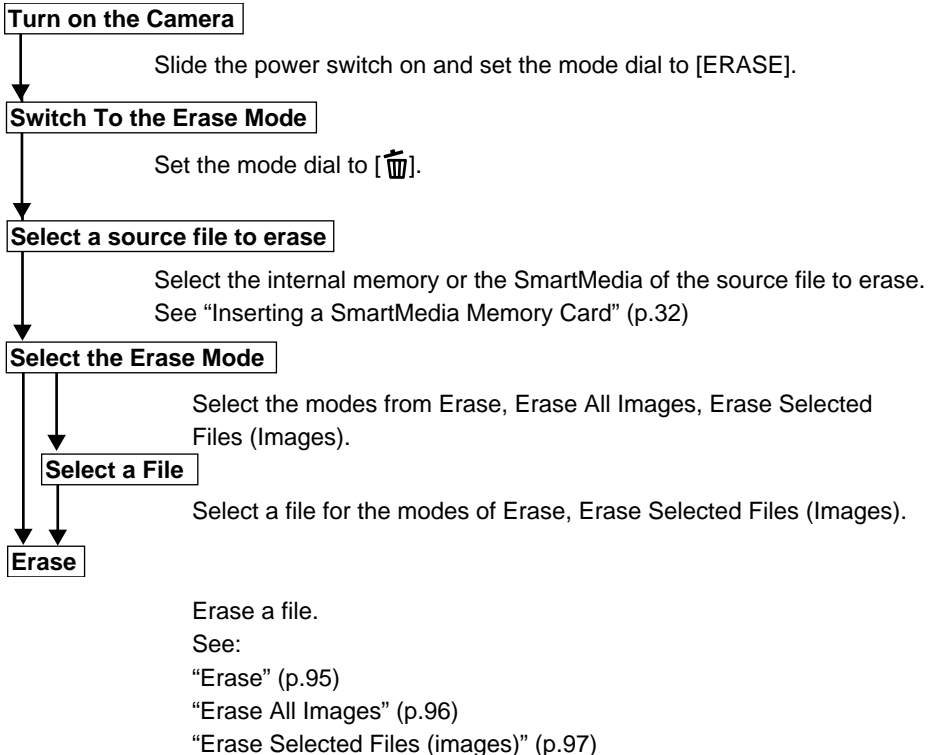

Erase

The selected file is erased.



- Remember that files cannot be restored once they are erased. Before starting to erase a file, make sure that you want to erase it.

- 1 **Set the mode dial to [] and press the CARD/IN button to select a source file to be erased.**

An erase menu is displayed.

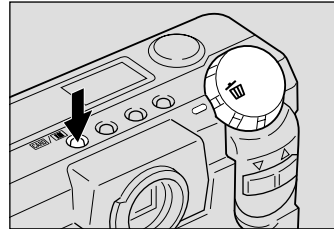

- 2 **Press the [] or [] button to select [ERASE SINGLE IMAGE] and press the ENTER button.**

The erase single image menu is displayed.



- To cancel the operation, set the mode dial to another mode.



- 3 **Press the [] or [] button to select an image file to erase.**



- To cancel the operation, press the MENU button. The erase menu is displayed.

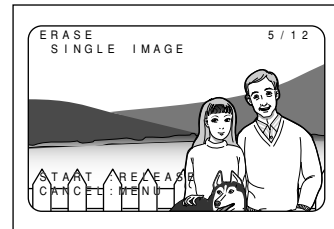

- 4 **Press the shutter release button.**

The image file thus selected is erased. If you want to erase more files, repeat steps 3 and 4 above.

4 above.

- 5 **Press the MENU button to end the ERASE SINGLE IMAGE operation.**

The erase menu is displayed again. Then, turn the mode dial to select another mode.

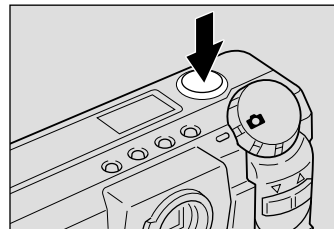

- When a lower numbered file is erased, the higher numbers are reassigned.
- Erasing may take longer with some types of SmartMedia memory cards and files.
- Protected files, which are identified by the [] mark, cannot be erased until they are unprotected. See "Protecting a File" (p.87).

Erase All Images

All recorded files are erased.



- Remember that files cannot be restored once they are erased. Before starting to erase files, make sure that you want to erase them.

- 1 **Set the mode dial to [TV] and press the CARD/IN button to select a source file to be erased.**

An erase menu is displayed.

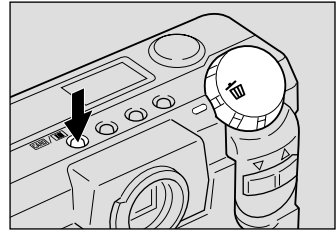

- 2 **Press the or button to select [ERASE ALL IMAGES] and press the ENTER button.**

The erase all images menu is displayed.



- To cancel the operation, set the mode dial to another mode.

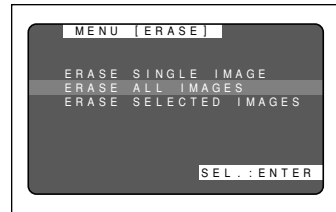

- 3 **Press the shutter release button.**

The “ERASING” message is displayed, and all the files are erased.



- To cancel the operation, press the MENU button. The erase menu is displayed.



The erase menu is displayed again after erasing all the images. Then, turn the mode dial to select another mode.



- High-capacity SmartMedia cards or larger number of files may take long time to erase.
- Protected files, which are identified by the mark, are not erased but remain on the SmartMedia memory card. See “Protecting a File” (p.87).

Erase Selected Files (Images)

Erases multiple selected image files.



- Files, once erased, cannot be restored. Before erasing files, check that you are sure you want to erase them.

- 1 **Set the mode dial to [] and press the CARD/IN button to select a source file to be erased.**

An erase menu is displayed.

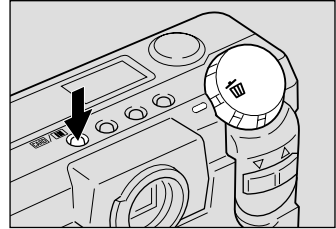

- 2 **Press the or button to select [ERASE SELECTED IMAGES] and press the ENTER button.**

The erase selected images menu is displayed.



- To cancel the operation, set the mode dial to another mode.



- 3 **Press the or button to select an image file to erase and press the ENTER button.**

The image file having the image number reversed is designated by the () mark. To select more files, repeat step 3 as many times as needed.

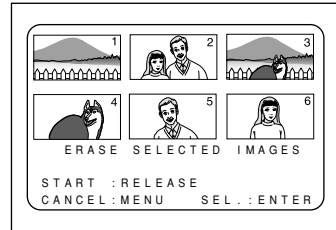

- To cancel copying a file bearing the () mark, press the ENTER key again.

- 4 **Press the shutter release button.**

The image files thus selected are erased.

The erase menu is displayed again after erasing the selected files. Then, turn the mode dial to select another mode.

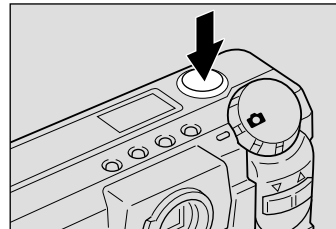

- Files may take time to erase, depending on the type of the SmartMedia memory card mounted and the file type.
- Protected files cannot be erased. Unprotect them before erasing them. See "Protecting a File" (p.87).

MISCELLANEOUS Chapter

5

Transferring Images to a PC	100
Changing Camera Settings	102
Beep Sound Setting	102
Auto Power Off Setting	103
Changing OSD (On-Screen Display)	
Language	104
Changing Video-Out Signal Method	
(NTSC/PAL)	105
Keep Settings	106
Formatting Internal Memory	107
Displays the Current Version Information	108
Changing LCD Confirmation	109
Changing the LCD Setting	110
Initializing Settings	111
Using the Remote Control	112
Shooting	112
Playing	113
Erasing	114
Accessories	116
Handling Precautions	117
Care and Storage	118
Troubleshooting	119
Using Your Digital Camera In Other Countries ...	122
About the Warranty and Servicing	123
Specifications	125
Recording Capacities	127
Ricoh Service Offices	129

Transferring Images to a PC

You can transfer recorded files to a personal computer by using an interface cable and software bundled with the camera.

■ Installing Camera Utility Software

Install the CD-ROM-based software (Camera utility Windows/Macintosh) (tentative name) bundled with the camera.

● PC Operating Platforms and Installation Instructions

○ Windows

- Operating system : Microsoft Windows 95/98/NT4.0
- PC : PC running Microsoft Windows 95/98
- CPU : Pentium or more
- Memory : • Windows95
16 MB or more (recommended 32 MB or more)
• Windows98/NT4.0
32 MB or more (recommended 48 MB or more)
- Hard drive space : 6 MB or more
- Display resolution : 640 × 480 dots or more (recommended 800 × 60 dots or more)
- Display colors : 256 or more (recommended 32,000 or more)
- CD-ROM drive : CD-ROM drive supported by Microsoft Windows 95/98

- Note** • The Camera utility software does not run under Windows NT3.51.
• The Camera utility software does not run under Windows 3.1.

○ Installation

Run the setup.exe file in the Camera utility for Windows (tentative name) folder on CD-ROM (Ricoh Digital Camera Software Suite) and install the Camera utility software as instructed by onscreen guidance messages.

- Note** Likewise, install other software than the Camera utility for Windows (tentative name) in Ricoh Digital Camera Software Suite by running the setup.exe file in each folder.

○ Macintosh

- Macintosh PC : Note or desktop Macintosh II or more
- CPU : 68040 or faster, or PowerPC
- Internal memory : 24 MB or more
- Required memory : 2 MB of uncompressed application memory space (recommended 4 MB or more)
- Hard drive space : 6 MB or more
- Display resolution : 640 × 480 dots or more (recommended 800 × 60 dots or more)
- Display colors : 256 or more (recommended 32,000 or more)
- Keyboard mouse : Keyboard and mouse connectable to the Macintosh PC used
- CD-ROM drive : CD-ROM drive supported by the Macintosh PC used

○ Installation

Copy the Camera utility icon CD-ROM (Software CD Suite) to the Macintosh HDD.

- Note** Likewise, install other software than the Software CD Suite by copying each icon to the Macintosh HDD.

■ Connecting the Camera to a PC

Use the interface cable bundled with the RDC-5000 to connect it to a personal computer.

❶ Turn off the PC.

❷ Connect the camera and the PC to each other using the interface cable, but not before checking to see that the camera is turned off.

- Note**
- Avoid operating the camera from batteries to the extent possible; rather, run it via an AC adapter. If the power turns off while you are operating the camera, you would have to retry.
 - Do not connect or disconnect the AC adapter to or from the AC outlet while the camera is turned on.

Typical Windows connection

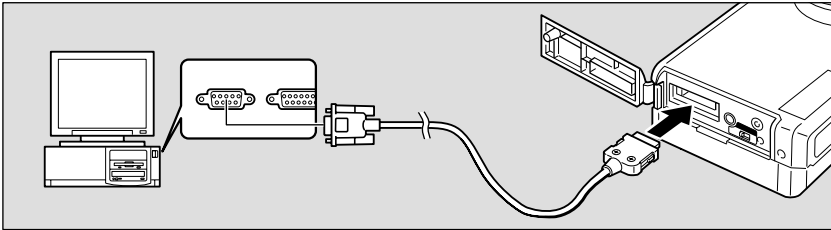

Typical Macintosh connection

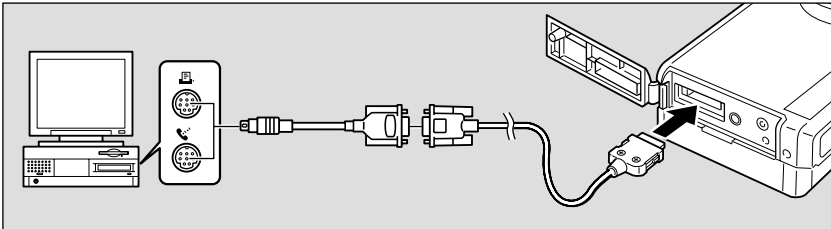

The above diagrams illustrate typical connections to the Ricoh digital camera RDC-5000.

❸ Turn on the camera and set the mode dial to [PC].

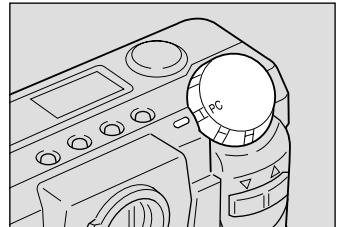

❹ Turn on the PC and run the utility software.

Changing Camera Settings

This camera enables you to change camera settings to meet your applications.

Beep Sound Setting

This camera beeps to alert you when it records a picture. You can disable the beep by following these steps.

1 Set the mode dial to [SETUP].

The setup menu is displayed.

- Note** • To cancel the operation, set the mode dial to another mode.

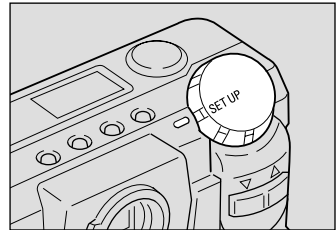

2 Press the **▲** or **▼** button to select [BEEP SOUND].

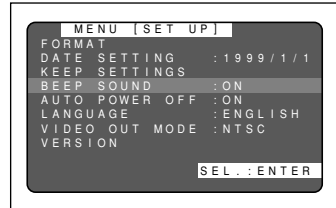

3 Press the **ENTER** button to select [OFF].

The beep is now disabled. When the setting is complete, set the mode dial to select another mode.

- Note** • An error beep is not suppressed even when [BEEP SOUND] is set to [OFF].

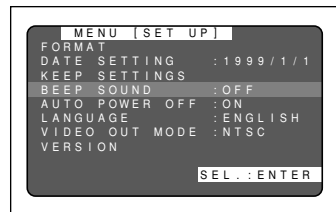

How To Cancel the Setting

Follow the above procedures and select [ON] in step 3. And the beep will be enabled.

Auto Power Off Setting

The camera will turn off automatically (auto power-off) in the recording and play modes to conserve the battery if it is in idle (no buttons or switches manipulated) for more than 5 minutes. The auto power-off mode can be disabled by setting it to off in either the record or play mode.

❶ Set the mode dial to [SETUP].

The setup menu is displayed.

- Note** • To cancel the operation, set the mode dial to another mode.

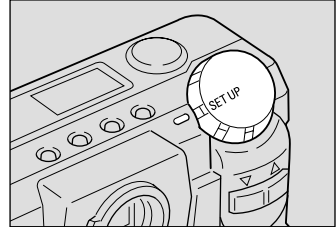

❷ Press the **POWER OFF** button to select [AUTO POWER OFF].

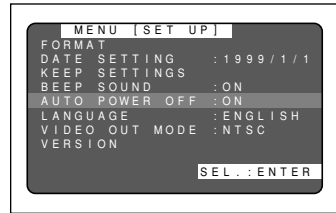

❸ Press the **ENTER** button to change the setting to [OFF].

The auto power-off mode is disabled.

When the setting is completed, set the mode dial to another mode.

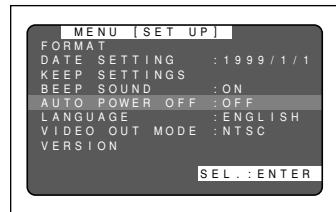

How To Enable the Auto Power Off Mode

Follow the above procedures, changing the setting to [ON] in step ❸. The auto power-off will be effective again.

- Note** • Slide the power switch to reactivate the camera if it shuts off in auto power-off mode.
- When using an AC adapter, the auto power-off function is disabled even if you have set the auto power-off mode to on. (Except the interval shooting)

Changing OSD (On-Screen Display) Language

Displays information appearing on the LCD monitor in one of two alternative languages, Japanese and English.

① Set the mode dial to [SETUP].

The setup menu is displayed.

- Note** • To cancel the operation, set the mode dial to another mode.

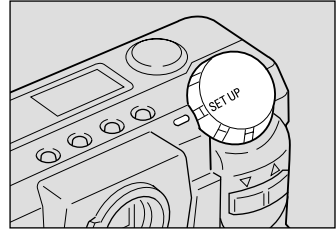

② Press the or button to select [LANGUAGE] and press the ENTER button.

A language setup menu is displayed.

- Note** • To cancel the operation and return to the setup menu, press the MENU button.

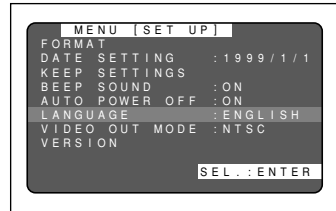

③ Press the or button to select a language and press the ENTER button.

The display language setting is updated and the setup menu is displayed again.

When the setting is complete, set the mode dial to select another mode.

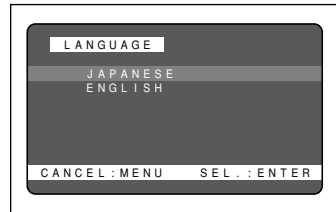

● Switching Back to English Display

When you have switched the LCD to Japanese display, choose [言語設定] from the SETUP menu and then choose [ENGLISH] from the resultant language setup menu to switch back English display.

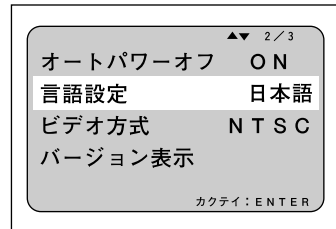

How To Cancel the Setting

Follow the above procedures and select the other language in step ③ above. The display on the LCD monitor will then change accordingly.

- Note** • Enable the save mode to save the language setting. See “Keep Settings” (p.106).

Changing Video-Out Signal Method (NTSC/PAL)

Switches the video system for connecting the camera to a TV set to play record images on TV.

See See "Using Your Digital Camera in Other Countries" (p.122).

1 Set the mode dial to [SETUP].

The setup menu is displayed.

Note • To cancel the operation, set the mode dial to another mode.

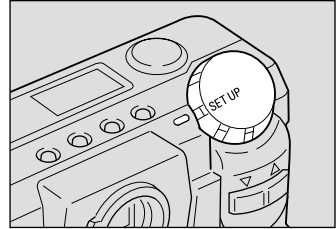

2 Press the or button to select [VIDEO OUT MODE].

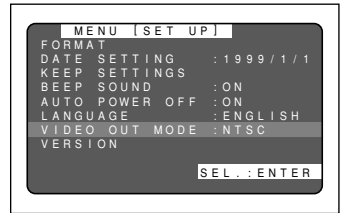

3 Press the ENTER button and select between [NTSC] and [PAL].

The video system setting is updated.

When the setting is complete, set the mode dial to select another mode.

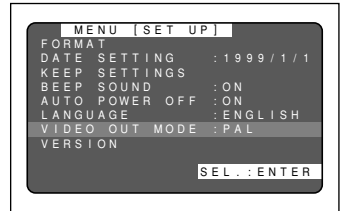

How To Cancel the Setting

Follow the above procedures and select the other video system in step 3 .

Note • When setting to PAL, this camera cannot be used as a monitor for the video printer, etc.
The LCD monitor would appear blank when the video cable is connected to video gear.

Keep Settings

The keep settings mode is for preserving settings after the power is turned off. Each setting is saved and becomes effective when the camera is powered. The following settings can be saved.

- Flash (p.55)
- Recording mode (p.44, 52)
- Date Imprint (p.71)
- CARD/IN (p.42)
- Exposure Compensation (p.60)
- White Balance (p.62)
- Language (p.104)
- S Mode (p.77)

1 Set the mode dial to [SETUP].

The setup menu is displayed.

- Note** • To cancel the operation, set the mode dial to another mode.

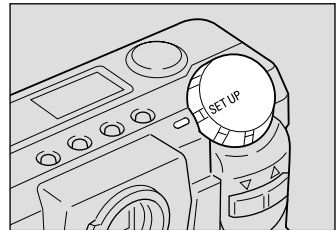

2 Press the **or** button to select [KEEP SETTINGS] and press the ENTER button.

The keep setting menu will be displayed.

- Note** • To cancel the operation and returns to the setup menu, press the MENU button.

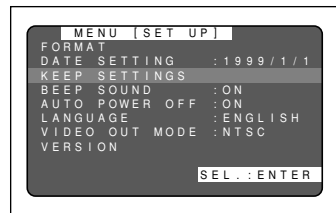

3 Press the **or** button to select a mode for setting the keep settings.

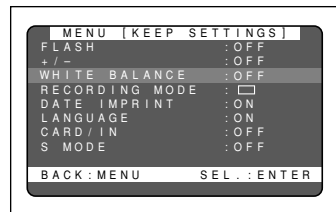

4 Press the ENTER button to change the setting to [ON].

With [REC Mode], press the enter button to select a mode to keep.

Keep Setting will be programmed. To program more items, repeat steps 3 and 4 as many times as needed.

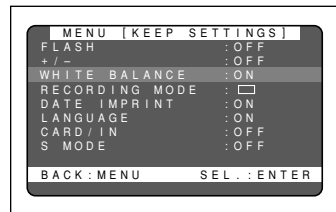

The settings of the items for which Keep Setting is programmed will be retained even when the camera is turned off.

5 After confirming the setting, press the MENU button.

The setup menu will be displayed. Set the mode dial to another mode.

How To Cancel the Settings

Follow the above procedures, changing the setting to [OFF] in step 4. The settings will now revert to their defaults when the power is shut off.

Formatting Internal Memory

When internal memory becomes full, format it.



- Formatting internal memory will erase all the files recorded in it, whether they are protected or unprotected. Copy files to the SmartMedia memory card as needed before formatting internal memory. See “Copying Image Files” (p.89).

1 Set the mode dial to [SETUP].

The setup menu is displayed.



- To cancel the operation, set the mode dial to another mode.

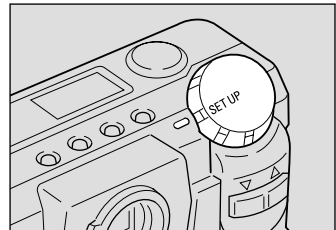

2 Press the or button to select [FORMAT] and press the ENTER button.

The format setup menu is displayed.



- To cancel the operation and return to the setup menu, press the MENU button.

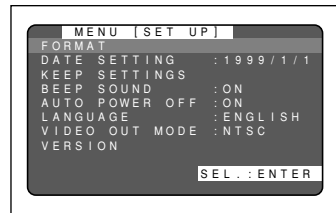

- 3 Press the **or** button to select **[FORMAT INTERNAL MEMORY]** and press the enter button.

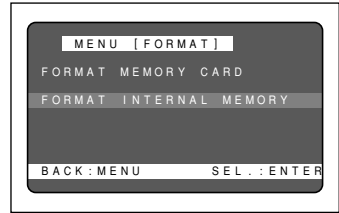

- 4 Press the shutter release button.
The message "FORMATTING" is displayed and formatting of internal memory begins.

When the formatting is complete, the setup menu is displayed again. Set the mode dial to select another mode.

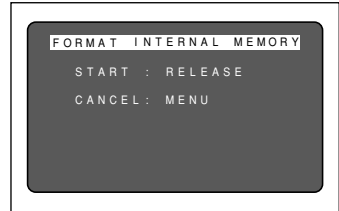

Displays the Current Version Information

You can view the current version information about your camera.

- 1 Set the mode dial to **[SETUP]**.

The setup menu is displayed.

- Note** • To cancel the operation, set the mode dial to another mode.

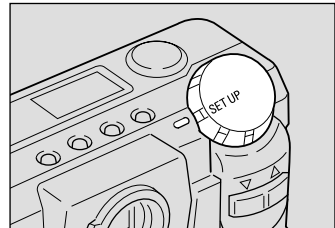

- 2 Press the **or** button to select **[VERSION]** and press the ENTER button.

The version information is displayed.

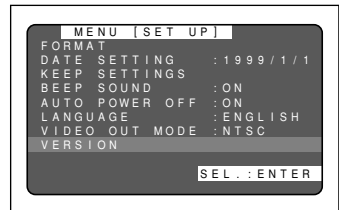

- 3 After confirming the version information, press the MENU button.

When the setup menu is displayed again, set the mode dial to select another mode.

Changing LCD Confirmation

When you press the shutter release button to take a picture, the shot image appears on the LCD monitor, accompanied by a beep, before it is recorded. You can select the image confirmation time from among 0 second, 1 second, 2 seconds, and 3 seconds.

1 Set the mode dial to [SETUP].

The SETUP menu will open.

- Note** • To cancel the operation, turn the mode dial.

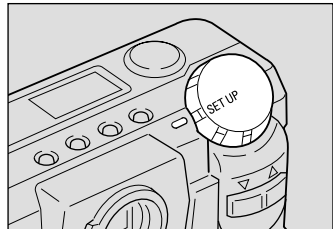

2 Press the or button to select [LCD CONFIRMATION].

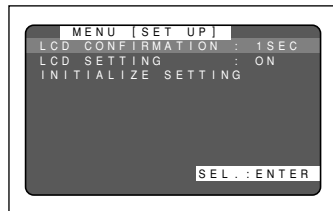

3 Press the enter button to select the image confirmation time.

The image confirmation time is selectable from among 0 second, 1 second, 2 seconds, and 3 seconds.

When the setting is complete, turn the mode dial to switch to another mode.

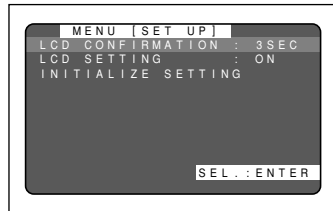

Restoring the Setting

Select [1 SEC] in step 3 above.

Changing the LCD Setting

The camera comes up with the LCD monitor enabled or disabled when it is powered on in a recording mode. You may set the camera to have the LCD monitor disabled when it is powered on, to save the batteries.

❶ Set the mode dial to [SETUP].

The SETUP menu will open.

- Note** • To cancel the operation, turn the mode dial.

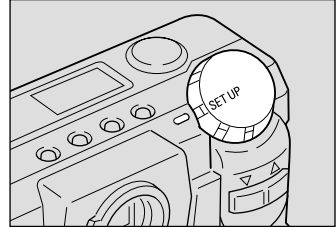

❷ Press the **[M]** or **[DISP]** button to select [LCD SETTING].

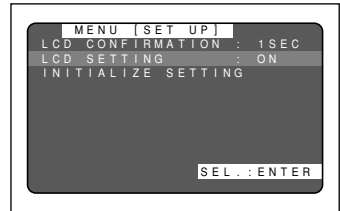

❸ Press the enter button to select [OFF].

The camera, when powered on in a recording mode, will now come up with the LCD monitor disabled. Press the DISPLAY button to switch the monitor display. See “LCD Monitor Display” (p.41).

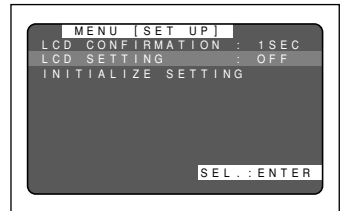

When the setting is complete, turn the mode dial to switch to another mode.

Restoring the Setting

Select [ON] as an LCD initial display option in step ❸.

Initializing Settings

You can reset all settings, except for the date.



- Data set by Keep Settings will also be initialized to its factory defaults.

1 Set the mode dial to [SETUP].

The SETUP menu will open.



- To cancel the setting, turn the mode dial to choose another mode.

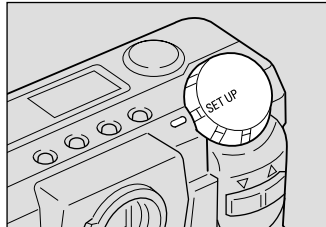

2 Press the or button to choose [INITIALIZE SETTING] and press the ENTER button.

The initialize settings menu will open.



- To cancel the operation, press the MENU button to return to the SETUP menu.

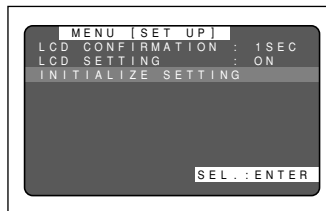

3 Press the shutter release button.

The settings will be reset to their factory defaults. Recorded files are preserved intact even when the settings are initialized.

When the initialization is complete, the SETUP menu appears again. Turn the mode dial to choose another mode.

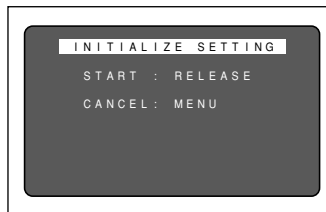

Using the Remote Control

The DR-3 remote control unit (optional) makes it possible to record and play back images from a remote location.



- The remote control receiver is located on the right side of the lens. Operate the remote control unit by pointing it at the remote control receiver.



- For instructions on replacing the batteries and maintaining the remote control unit, refer to the accompanying manual.
- Some procedures differ when performed on the remote control unit and on the camera itself. Follow the instructions below to use the remote control unit.

Shooting

The remote control unit can be used to operate the camera. It is particularly convenient when the camera is set up at a remote location or is in a fixed position.

- 1 **Set the mode dial to [📷] and press the CARD/IN button to select a recording destination.**

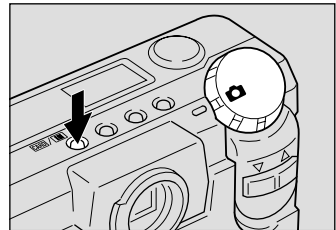

- 2 **Decide the composition of the picture and press the RELEASE button on the remote control unit.**

The self-timer LED will light and recording will start about 2 seconds later.



- Use the zoom buttons to vary the size of the subject. The [📈] button magnifies the subject (telephoto), while the [📉] button decreases the size of the subject (wide angle).

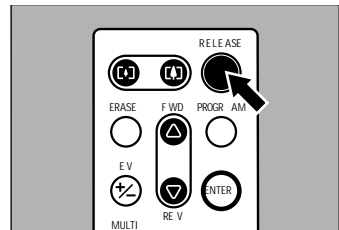

Setting Exposure Compensation

● Starting setting

Press the EV (+/-) button on the remote control unit.

● Setting the exposure compensation level

Set the exposure compensation level using the FWD () or REV () button and press the ENTER button on the remote control unit. And then press the RELEASE button to take a picture.

● Canceling the setting

Set the exposure compensation level to ± 0.0 .

Shooting in Manual Focus Mode

● Entering the mode

Press the ERASE button on the remote control unit.

● Focusing

Focus on the subject using the FWD () or REV () button. Press the RELEASE button to take a picture.

● Canceling the mode setting

Press the ERASE button again.

Playing

Use the remote control unit to playback recorded files.

- 1 Set the mode dial to [] and press the CARD/IN button to select a recording destination.

The most recently recorded file will be played back.

See "Playback Display" (p.80)

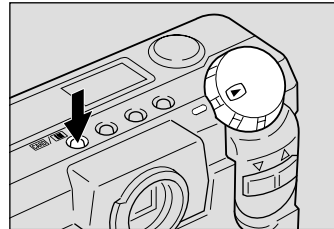

- 2 Choose a file by pressing the FWD () or REV () button on the remote control unit.

Note • The remote control unit buttons are operated in the same way as the buttons on the camera.

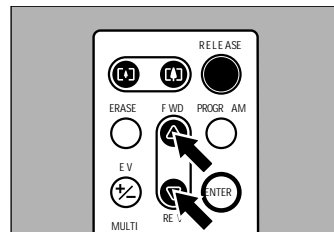

Magnifying an Image (Zoom Playback)

● Entering the mode

Press the PROGRAM button on the remote control unit.

● Moving the playback position

Press the FWD () or REV () button.

● Canceling the mode setting

Press the ENTER button to return to the normal playback display.

Displaying Multiple Images (Multi Image Playback)

● Entering the mode

Press the MULTI button on the remote control unit.

● Moving the selected file

Press the FWD () or REV () button.

● Canceling the mode setting

Press the ENTER button and the selected file will appear on the normal playback display screen.

Erasing

You can use the remote control unit to erase a recorded file at a time.



- Remember that files cannot be restored once they are erased. Before starting to erase files, make sure that you want to erase them.

- 1 Set the camera's mode dial to []. And press the CARD/IN button to select a source file to erase.

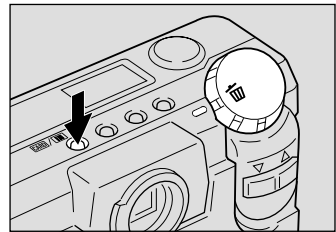

- 2 The erase menu will open. Use the FWD () or REV () button to select an erase mode.

Select [ERASE SINGLE IMAGE] from the erase menu to erase selected images one at a time.

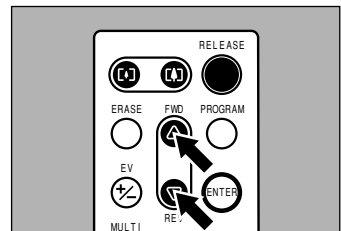

- ③ Select a file to be erased by pressing the FWD () or REV () button on the remote control unit.

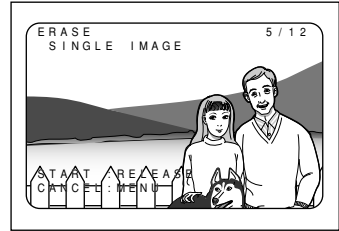

- ④ Press the RELEASE button on the remote control unit.

The file will be erased. To erase more files, repeat steps ③ and ④ as often as required.

When erasure is completed, turn the mode dial to switch to another mode.

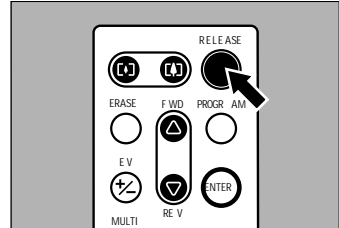

- Note** • If you select [ERASE ALL IMAGES] or [ERASE SELECTED IMAGES] in step ②, you can work with the remote controller the same way as you do with the camera.

Accessories

Item	Model	Remarks
AC Adapter	AC-3	For drawing power directly from a household electrical outlet. See "Using an AC Adapter" (p.29).
Remote Control Unit	DR-3	For remote operation of the camera's recording and playback functions.
SmartMedia Memory Cards		A postage stamp-sized storage media with a thickness of 0.76 millimeters.
4 M	FS-4	Capable of storing a maximum of (9) images recorded in 1800N mode.
8 M	FS-8	Capable of storing a maximum of (19) images recorded in 1800N mode.
16 M	FS-16	Capable of storing a maximum of (38) images recorded in 1800N mode.
32 M	FS-32	Capable of storing a maximum of (76) images recorded in 1800N mode.
PC Card Adapter	FS-B53	Used to insert the SmartMedia memory card directly into the PC card slot.
Floppy Disk Adapter	FS-B10	Used to insert the SmartMedia memory card directly into the PC floppy disk drive.

- Microsoft, MS and Windows are registered trademarks of Microsoft Corporation in the United States of America and other countries.
- Macintosh is a registered trademark of Apple Computer, Inc., in the United States of America and other countries.
- All trademarked company and product names mentioned in this manual are the property of their respective owners.

Handling Precautions

- This camera is not waterproof. Keep away from water, rain, beverages, etc. Consult your nearest Ricoh service office if any liquid gets into the camera.
- Be careful not to drop the camera or subject it to impacts.
- Do not use the flash more than necessary in continuous shots to avoid overheating.
- Never look through the viewfinder directly at the sun or intense light. Your eyesight may be impaired.
- Do not fire the flash close to a baby or infant's eyes.
- Do not fire the flash by aiming the camera at a driver behind wheel. A traffic accident may result.
- Exercise caution to prevent sand or dust from getting into the camera in such environments as beaches or work sites.
- Do not leave the camera for any length of time in particularly hot or humid places, such as an automobile with the windows closed, beaches or bathrooms.
- Verify that the camera power is off before you attach the AC adapter.
- Direct sunlight and strong light striking the LCD monitor or the LCD panel will reflect white light, making it difficult to view.
- The LCD monitor or the LCD panel may contain some pixels that always or never illuminate and the brightness of some areas of the monitor may appear uneven. These are typical LCD performance characteristics and do not constitute malfunctions.
- Do not force any of the external moving parts, such as the card door, terminal cover or battery cover.
- Do not lift the camera by the hard cover, terminal cover or battery cover.
- Do not impede movement of the lens barrier while turning on the power.
- Be careful not to hit the lens unit or the LCD monitor while carrying the camera.
- Extreme temperature differentials may cause condensation to form inside the camera body and lens unit, reducing performance. To avoid this, place the camera in a plastic bag and let it slowly acclimatize to the new temperature before exposing it.

Potential Causes of Condensation

- Transporting the camera from a cold place to a warm place.
- Storing or using the camera in places subject to high humidity.
- Bringing the camera into a recently heated room or leaving it directly in the path of air conditioning.

Care and Storage

■ Care

- Fingerprints or dirt on the lens will reduce performance so take extra care not to get it dirty.
 - Do not wipe dust or smears off the lens with your fingers. Use a lens blower, readily available at most photographic suppliers, to blow dust off, or a very soft cloth to wipe it lightly.
 - Be particularly diligent in cleaning the lens after use at the beach or around chemicals.
 - If your camera should malfunction, take it to the nearest Ricoh service office. This product generates high voltages and disassembly is hazardous. Under no circumstances should you attempt to disassemble it yourself.
 - Never use solvents, benzene, insecticides or other volatile substances on the equipment as this may deform or dissolve it.
 - Be careful not to let objects rub against the LCD monitor or the LCD panel as it is readily susceptible to scratching.
 - To clean the LCD monitor or the LCD panel, wipe it gently with a soft cloth that has been moistened in diluted detergent and well-wrung. Wipe off any moisture with a soft, dry cloth.
- * Remove the batteries and AC adapter from the camera before commencing any of the above.

■ Storage

To prevent possible failures, avoid storing the camera in places that are:

- Hot and damp, or subject to sharp temperature or humidity changes.
- Sandy or dusty.
- Subject to strong vibrations.
- In contact with chemicals, such as insecticides, or rubber or PVC products for extended periods of time.
- Near sources of strong electromagnetism (such as motors, transformers, and magnets).

Troubleshooting

Refer to the pointers listed below before submitting the equipment for repairs. If the problem persists after trying the suggestions, contact the nearest Ricoh service office listed at the back of this manual.

■ Power Source

Problem	Cause	Solution	Page
Power will not come on	Batteries dead, improperly installed or missing	Insert the batteries correctly or replace them.	27
	AC adapter not attached correctly	Attach correctly again.	29
	Card door open	Close the card door and retry starting.	32
Power cuts out	No buttons touched so auto power-off function was activated	Restart camera.	41
	Dead batteries	Replace with new batteries.	27
Battery quickly consumed	Camera operated in extremely high or low temperature location	–	–
	Camera operated in dark area requiring frequent use of the flash	–	–

■ Recording and Playback

Problem	Cause	Solution	Page
Shutter release button pressed but no image recorded	Batteries dead, improperly installed or missing	Replace or reposition batteries.	27
	No power, or mode dial is not set	Slide power on and set mode dial to [📷]	41
	Shutter release button only pressed halfway	Press shutter release button all the way.	48
	SmartMedia memory card not formatted (initialized)	Format SmartMedia memory card.	33
	No space on SmartMedia memory card	Erase unimportant files or replace SmartMedia memory card.	32, 94
	No space on internal memory	Erase unimportant files	94
	SmartMedia memory card not working (service life exceeded)	Replace SmartMedia memory card.	32
	Card door open	Ensure that card door is securely closed.	32
	Self-timer on	Press the self timer button to disengage the self timer recording mode.	67
	Flash is charging	Wait until flash LED ceases flashing.	49
SmartMedia memory card contact surface dirty	Clean contact surface with soft dry cloth.	31	
Cannot confirm a shot picture	The image confirmation time is too short.	Make the image confirmation time longer.	109
No image on the LCD monitor	The LCD monitor is turned OFF.	Press the DISPLAY button to turn ON the LCD monitor, or set [LCD Initialization] to [ON].	41, 110
	The video I/O switch is set on [IN].	Set video I/O switch is set on [OUT].	81
Autofocus is on but camera not focusing	Dirty lens	Clean lens with blower or soft dry cloth.	–
	Subject not in the center of the autofocus field	Use focus lock	68
	Subject difficult to focus	Use focus lock or switch to manual focus.	68, 70

Problem	Cause	Solution	Page
Flash won't fire, or won't charge	Camera not set to PIC mode	Use record menu to set record to PIC mode.	44
	Camera set to flash off mode	Cancel the flash off mode with flash button.	56
	White balance mode set to setting other than auto	Use record menu to set the white balance to auto.	62
	Batteries dead	Replace batteries.	27
Image dark even with flash	Subject farther than approx. 3.0 m (9.9 feet) with the zoom on telephoto or approx. 3.4 m (11.2 feet) with the zoom on wide angle	Come closer to subject.	55
Image is too bright	The camera is too close to the subject.	Retake picture without flash.	56
	Over-exposed	Use record menu to adjust exposure compensation.	60
	Brightness setting of LCD monitor not adjusted	Adjust brightness adjustment dial.	37
Image is too dark	Shot in low light area with camera set to flash off mode	Press the flash button disengage flash off mode.	56
	Under-exposed	Use record menu to adjust exposure compensation.	60
	Brightness setting of LCD monitor not adjusted	Adjust brightness adjustment dial.	37
Unnatural coloration of image	Shooting conditions difficult for white balance in auto mode	Place a white object near the subject, use the flash or select one of the manual white balance modes.	56, 62
Date and other recording data will not display	Screen display set to off	Press the ENTER button to switch screen display mode.	50
Can't playback or image won't appear	Camera not set to play mode	Set mode dial to [D].	83
	The playback source is different	Press the CARD/IN button to change the playback source	83
	SmartMedia memory card not installed or doesn't contain any files	Insert a SmartMedia memory card with recorded images.	32
	Use SmartMedia memory card not formatted by your camera	Use a SmartMedia memory card that has been formatted and recorded by your camera.	32
	SmartMedia memory card contains incorrectly recorded files	Insert a SmartMedia memory card containing pictures properly recorded by the camera.	32
	SmartMedia memory card contains files in a format not read by the camera.	Check the format type	82
	Card door open	Ensure that card door is securely closed.	32
	Video interface cable poorly connected	Check connection.	81
	Source of interference, such as electric motor, nearby	Relocate camera away from source.	–
	SmartMedia memory card contact surface dirty	Clean contact surface with soft dry cloth.	31
	The video I/O switch is set on [IN].	Set video I/O switch is set on [OUT].	81
Replay is not clear	Error in internal memory in the camera	Copy required files from internal memory to the SmartMedia memory card and format internal memory.	89, 107
	Error with SmartMedia memory card	Test camera with another SmartMedia memory card. If second card displays well, problem is with card not camera.	–

Problem	Cause	Solution	Page
Display shut off	Dead batteries	Replace batteries.	27
	Auto power-off activated	Slide power on again.	41
Remote control unit will not work	Obstruction between the remote control unit and camera sensor	Remove the obstruction. (Sensor is on the left side of the lens.)	–
	Dirty remote control transmitter or camera sensor	Clean with a soft dry cloth.	–
	Dead remote control batteries	Replace CR2032 lithium batteries.	–
LCD monitor brightness changes during autofocus operation	Area captured by autofocus field and the surrounding area have contrasting light levels or the entire subject is dark.	There is no malfunction.	–
Vertical lines appear on image	Phenomenon occurring with pictures of bright subjects, known as the smudge phenomenon	There is no malfunction. Never shoot the Sun, etc.	–

■ Miscellaneous

Problem	Cause	Solution	Page
SmartMedia memory card will not fit into slot	Wrong type of SmartMedia memory card	Use a SmartMedia memory card specified for the camera.	32
	SmartMedia memory card incorrectly oriented	Insert the SmartMedia memory card the correct way.	32
Camera will not operate even when buttons and switches are manipulated	Dead batteries	Replace batteries.	27
	Camera malfunction	Slide the power off and on once. Turn the mode dial to [] or []. If the problem persists, (1) reset the camera by sliding the power switch after removing the main batteries, and (2) reinstall the batteries and try to operate the camera again.	–
Date and time are wrong	Date and time setting is incorrect	Reset the date and time.	35
Date and time were set but disappeared	Battery removed	The date setting is reset if the battery has been removed for about 3 minutes or longer. Set the date again.	35
Fill won't erase or SmartMedia memory card won't format	Camera not set to erase mode	Turn the mode dial to [].	94
	Write protect pad on SmartMedia memory card	Remove pad from SmartMedia memory card.	31
	File protected	Use the play menu to reset the file's protection setting.	87
	Power switch off or auto power-off activated.	Slide power on and retry.	102
Mode settings have changed	Batteries have been removed	Reset mode.	102
Auto power-off will not activate	Auto power-off setting is disabled	Enable setting.	103
	Camera powered by AC adapter (auto power-off is automatically disabled when powered by an AC adapter)	–	–
Beep will not sound	Beep disabled	Set beep sound to [ON] on the SETUP menu.	102
	No image on the TV screen		
	The video I/O switch is set on [IN].	Set video I/O switch is set on [OUT].	81
	The television system setting is incorrect.	Select the correct television system.	105
	The output video gear has an incorrect video I/O switch setting.	Check to see if the output video gear has a correct video I/O switch setting.	–

Using Your Digital Camera in Other Countries

Ricoh AC-3 AC adapter (optional)

- The AC-3 AC adapter adjusts automatically to voltages ranging from 100V to 240V AC and frequencies of 50Hz to 60Hz.
- Some countries use electrical outlets which have different shapes. Before leaving on a trip, obtain the necessary plug adapter from a travel agent or electric store.

Using a Local TV Receiver for Playing Pictures

- You can play pictures taken with this camera on a TV receiver (or monitor) furnished with a video input terminal. Use the video interface cable supplied.
- This camera supports two television systems: NTSC and PAL. Switch your camera's video system to meet the local video environment. See "Changing Video-Out Signal Method (NTSC/PAL)" (p.105).
- If you plan to take the camera with you on a trip abroad, identify the local television system beforehand.

About the Warranty and Servicing

1. The Ricoh RDC-5000 camera is backed by a one-year limited warranty. During the warranty period, which starts from the date of purchase, any defective parts will be repaired free of charge. In the event of a camera malfunction, contact the dealer from which you purchased the camera or contact the nearest Ricoh service office. Please note that you will be charged for the cost of shipping the camera from the Ricoh service office to your residence.
2. This warranty does not cover any damage resulting from:
 - ① Failure to follow the instructions in this instruction manual;
 - ② Repair, modification or overhaul not conducted by an authorized service center specified in this instruction manual;
 - ③ Fires or natural disaster;
 - ④ Improper storage, such as exposing the camera to high temperatures, humidity, or mothballs; storing it with leaking batteries; storing the camera in a dirty condition so that it becomes moldy; or otherwise insufficiently caring for the camera.
 - ⑤ Submergence; exposure to floods or spilled alcoholic or other beverages; allowing sand or mud to enter the camera; exposure to physical shocks; or dropping of the camera.
3. After a full year has passed from the purchase date, you will become responsible for all repair fees, including those incurred at an authorized service center.
4. You will be responsible for all repair fees, even within the warranty period, if the warranty card is not attached or if the distributor's name or the purchase date have been changed or are not indicated on the card.
5. Expenses for overhauls and thorough inspections as a result of a customer's special request will be charged to the customer, whether or not they are incurred during the warranty period.
6. This warranty only applies to the camera and not to the accessories, such as the hard case and wrist strap, nor does it apply to the consumables provided, such as batteries.
7. Any consequential damage arising from the failure of this camera, such as expenses for taking pictures or loss of expected profit, will not be reimbursed whether it occurs during the warranty period or not.
8. The above provisions refer to repairs offered free of charge, and do not limit your legal rights. The intention of the above provisions is also described in the warranty card provided with this camera.
9. Parts essential to the servicing of this camera - that is, components required to maintain the functions and quality of this camera - will be available for a period of seven years after the camera is discontinued. However, as some of those parts are kept for a longer period, do not hesitate to contact your distributor or the nearest Ricoh service representative even after the seven-year period.
10. Please note that, if the camera is seriously damaged from flooding, submergence, infiltration of sand or mud, violent shocks or dropping, the camera may not be repairable, and restoration to its original condition may be determined to be impossible.

 **Note**

- Before sending the camera in for repair, check the batteries and read this instruction manual again to ensure proper operation.
- Some repairs require a significant amount of time to be completed. Please allow sufficient time for repairs.
- When sending the camera to a service representative, please include a note which describes the defective part and the problem as precisely as possible.
- Remove all accessories not related to the problem before sending the camera to a service representative.
- Before taking any important pictures (such as at weddings, on trips abroad, etc.) test the camera to check its operation and ensure proper functioning. We recommended that you keep this manual and spare batteries on hand.

Specifications

■ General

- **Video Signal Protocol** : PAL/NTSC
- **Power Source and Voltage** : Batteries: 6 volts
AC: 5 volts
- **Dimensions (W × H × D)** : 131.1 × 68.8 × 45.2 mm (5.17" × 2.71" × 1.78")
(excluding grips)
- **Weight** : Approximately 315 g (11 oz.) (excluding batteries)
- **Operating Range - Temperature** : 0° to 40° C (32° to 104 F)
- **Operating Range - Relative Humidity** : 85% or less
- **Storage** : -20° to 60°C (-4° to 140°F)

■ Camera

- **CCD** : 2,300,000 million square pixels (effective: 2,190,000 million)
- **Lens** : Zoom lens F=2.8 - 3.2
 - Focal length : f=8 - 18 mm (equivalent to 38-86 mm on 35mm camera format)
 - Minimum shooting range : Approximately 4 cm (1.6") (macro)
- **Viewfinder**
 - Type : Real image
 - Magnification : Telescope 0.34X, standard 0.56X, wide angle 0.77X
 - Parallax correction : No
 - Diopter : -1 dpt
- **Monitor**
 - Display Size : 1.8"
 - Drive System : TFT Active Matrix System
 - Picture Elements : Approximately 110,000 pixels
- **White Balance** : Auto/Preset (Daylight, Cloudy (Overcast), Fluorescent Light, Tungsten Light)
- **Exposure Compensation**
 - Light Metering System : Centerweighted
 - Exposure Value Memory System : Auto backlighting detection
Manual compensation, ±2.0 EV (in 0.5 EV increments)
 - Metering : TTL-CCD method
 - Flash Automatic Exposure : Yes (daylight synchro)
 - Shutter Speed : 1-1/500
 - Minimum diaphragm setting : F 13.5 – F 14.4
 - ISO Sensitivity : Approximately equivalent to 100
- **Distance Adjustment**
 - Autofocus Method : TTL-CCD AF
 - Autofocus Range : 4 cm (1.6") to infinity

● Built-in Flash

- Type : Auto
- Range : About 0.4 to 3.0 m (telescope)
About 0.4 to 3.4 m (wide angle)
- Modes : Off/On (Forced flash/Slow synchro)/Auto/Red-eye reduction

■ Image Data Recording and Playback

● Image Resolution : 1792 × 1200, 896 × 600 pixels

● File Format : JPEG (Exif2.1)

● Camera : File System standard: Design rule for Camera File System (DCF)

● Compression Format : JPEG baseline method

● Approximate File Sizes

- 1792 × 1200 : F mode: approx. 795 KB, N mode: approx. 401 KB, E mode: approx. 204 KB,
- 896 × 600 : F mode: approx. 270 KB, N mode: approx. 139 KB, E mode: approx. 73 KB
- 640 × 480 : F mode: approx. 157 KB, N mode: approx. 82 KB, E mode: approx. 45 KB

■ Input/Output Terminal

- Power input : 5 V (AC adapter)
- Video output : 1.0 V_{p-p} (75 W)
- RS-232 C/AUX : For connecting to a PC

■ Body

● Tripod Screw Hole

- Power Supply : Tapped (1/4-20 UNC)
: Length: less than 5.7 mm (0.22")

■ Main Batteries

- Type : AA alkaline batteries
: AA Ni-MH batteries
: AA Ni-Cd batteries
- Voltage : 6 volts (1.5 volts × 4 batteries)

● Date backup battery

- Battery type : Super-capacitor
- Duration : About 3 minutes

● Auto Power-Off : Activated after more than 5 minutes

■ Internal Memory

- Capacity : 8 MB

■ Compatible Memory Cards for Recording and Playback

- Type of Memory : SmartMedia memory card
- Capacity : 2, 4, 8, 16, 32 MB
- Operating Voltage : 3.3 volts

Recording Capacities

The table below gives approximate recording picture counts available by SmartMedia memory card capacity and by PIC mode.

Type	PIC Mode	Recording Mode	Approximate Recording Picture counts
2MB	1800 × 1200	F	2
		N	4
		E	9
	900 × 600	F	7
		N	14
		E	26
	640 × 480	F	12
		N	23
		E	41
4MB	1800 × 1200	F	4
		N	9
		E	19
	900 × 600	F	14
		N	27
		E	49
	640 × 480	F	24
		N	45
		E	82
8MB	1800 × 1200	F	9
		N	19
		E	38
	900 × 600	F	29
		N	55
		E	99
	640 × 480	F	49
		N	90
		E	165

Type	PIC Mode	Recording Mode	Approximate Recording Picture counts
16MB	1800 × 1200	F	19
		N	38
		E	76
	900 × 600	F	58
		N	110
		E	199
	640 × 480	F	99
		N	166
		E	332
32MB	1800 × 1200	F	39
		N	76
		E	153
	900 × 600	F	117
		N	221
		E	399
	640 × 480	F	199
		N	332
		E	665



- The picture size of 640 × 480 is available with the digital zoom function enabled.
- Internal memory is similar to an 8 MB SmartMedia memory card.



Declaration of Conformity

“The Product complies with the requirements of the EMC Directive 89/336/EEC.”

INFORMATION TO THE USER

USA FCC Part15 Class B

The equipment has been tested and found to comply with the limits for a Class B digital device, pursuant to part 15 of the FCC Rules. These limits are designed to provide reasonable protection against harmful interference in a residential installation. This equipment generates, user, and can radiate radio frequency energy and if not installed and used in accordance with the instructions, may cause harmful interference to radio communications. However, there is no guarantee that interference will not occur in a particular installation. In this equipment does cause harmful interference to radio or television reception, which can be determined by turning the equipment off and on, the user is encouraged to try to correct the interference by one or more of the following measures:

- Reorient or relocate the receiving antenna.
- Increase the separation between the equipment and receiver.
- Connect the equipment to outlet on a circuit different from that to which the receiver is connected.
- Consult the dealer or an experienced radio/TV technician for help. (FCC 15.105B)

Changes or modifications not expressly approved by the party responsible for compliance could void the user's authority to operate the equipment. (FCC 15.21)
Properly shielded and grounded cables and connectors must be used for connection to a host computer in order to comply with FCC emission limits. (FCC 15.27)
An AC adapter with a ferrite core must be used for RF interference suppression.

COMPLIANCE INFORMATION STATEMENT

Product Name: Ricoh Digital Camera

Model Number: RDC-5000

This device complies with Part 15 of the FCC Rules.

Operation is subject to the following two conditions:

- (1) This device may not cause harmful interference, and
- (2) This device must accept any interference received, including interference that may cause undesired operation.

RICOH CORPORATION

5 Dedrick Place, West Caldwell NJ, 07006 Tel.: 1-800-225-1899

Note to Users in Canada

Note: This Class B digital apparatus complies with Canadian ICES-003

Remarque Concernant les Utilisateurs au Canada

Avertissement: Cet appareil numérique de la classe B est conforme a la norme NMB-003 du Canada

IMPORTANT SAFETY INSTRUCTIONS-SAVE THESE INSTRUCTIONS DANGER-TO REDUCE THE RISK OF FIRE OR ELECTRIC SHOCK, CAREFULLY FOLLOW THESE INSTRUCTIONS.

Ricoh Service Offices

Ricoh Co., Ltd.
Ohmori NM Building
1-1 Ohmori-Kita 2-chome
Ota-ku, Tokyo
143-0016 JAPAN
<http://www.ricoh.com>

Ricoh Factory Service Center
3235 Sunrise Blvd.,
Suite2 Rancho Cordova,
CA 95742
<http://www.ricohcpg.com/>

Ricoh Europe B.V.
Photo Products Division
P.O. Box 75640
1118 ZR Schiphol
The Netherlands
<http://www.ricoh-red.com/>
<http://www.ricoheurope.com/>
E-mail:camera@ricoh.nl

Ricoh Europe B.V.
European Digital Solution Center
Oberrather Straße 6
D-40472 Düsseldorf
Germany

Ricoh Photo Products (Asia), Ltd.
Unit D, E & F
24/F., China Overseas Building
139 Hennessy Road, Wan Chai
Hong Kong

Ricoh Australia Pty. Ltd.
148 Highbury Road
Burwood, Victoria, 3125
Australia
<http://www.ricoh-aust.com.au>



RICOH CO., LTD.

Ohmori NM Building
1-1 Ohmori-kita 2 chome
Ota-ku, Tokyo
143-0016 Japan
L 2092546A

