

Introduction

Thank you for purchasing the Ricoh RDC-300 Digital Camera. This manual contains instructions on the proper use of your camera as well as the necessary handling precautions. Read this manual thoroughly and carefully to understand the proper use of the camera.

Ricoh Co., Ltd.

Testing the camera

Always test the camera by taking several sample pictures to confirm that the pictures are correctly recorded.

Respecting copyrights

Reproduction or alteration of copyrighted documents and magazines other than for personal or family use or to a similarly limited extent, without the consent of the author, is prohibited.

About digital audio visual files

We regret that we cannot be responsible for files lost due to any malfunction of the camera.

About the warranty

This product is made to local specifications. Should it malfunction while you are abroad, we cannot be responsible for the cost or availability of service in other countries.

Radio-frequency interference

Using the digital camera near electric devices could inhibit the performance of both the camera and nearby devices. Interference is likely to occur when the camera is placed near a radio or television. If this condition occurs, perform the following procedures:

- Relocate the camera as far as possible from the interference source.
 - Change the orientation of the radio or television antenna.
 - Plug the camera into a different electrical outlet.
 - This booklet may not be copied in whole or in part without the expressed written permission of the publisher. ©1997 RICOH CO., LTD.
 - The contents of this manual are subject to change without notice.
 - Considerable care was taken in the preparation of this manual. However, if any part of the manual is unclear or incorrect, please contact us at the address indicated on the back cover.
- Microsoft, MS-DOS and Windows are trademarks of the Microsoft Corporation of the U. S. A. and are registered in the U. S. and other countries.
Macintosh is a trademark of Apple Computer Inc. of the U. S. A. and is registered in the U. S. and other countries.
All trademarked product names mentioned in this manual are the property of their respective companies.

Camera Description

Recording quickly

Recording can be performed quickly and simply by determining the image composition while observing the LCD monitor and pressing the shutter release button because the memory is internally equipped in the main unit of the camera.

Confirming a file right after recording

A recorded file can be confirmed by the LCD monitor right after the recording. The playback can be performed by just switching to the playback mode.

Large number of pictures can be taken by switching the mode.

Three types of image quality modes can be set. These modes include the standard normal mode, the fine mode that sets the recording priority on image quality and the economy mode for recording large numbers of images. The mode can be switched according to the application.

Natural color images

The subject can be shot with a natural color under any lighting conditions such as outside sunlight or inside room light by the Auto white balance function.

Close-up shooting is possible.

It is possible to approach a subject as close as a distance of 1cm. This type of close-up is called macro shooting and is appropriate for pictures of flowers or insects or other detailed subjects.

Monitoring on TV

A recorded file can be played back on a TV monitor by connecting the accessory video connecting cable. Dubbing to a video cassette tape and full-color printouts are also possible by connecting the camera to a video or a video printer (NTSC only).

Compact size for easy to carry

The compact size and light weight of the camera enable easy carrying. This camera has an optional Hard case making it easy to take it with you anywhere.

Files can be transferred to a computer.

Files can be transferred to a computer using the software for the RDC-300. The input file can be printed out by using a color printer and color copier.

Parts and Names

■ Camera main unit (Top)

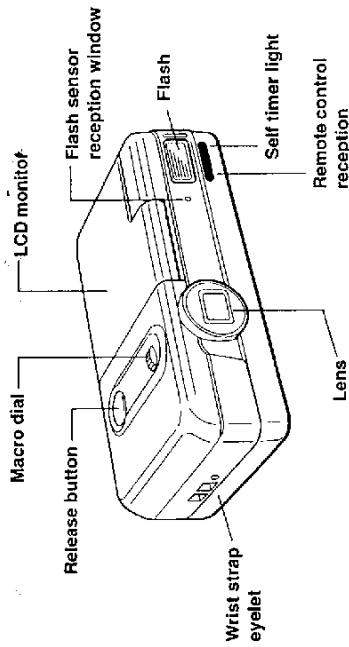

(Bottom)

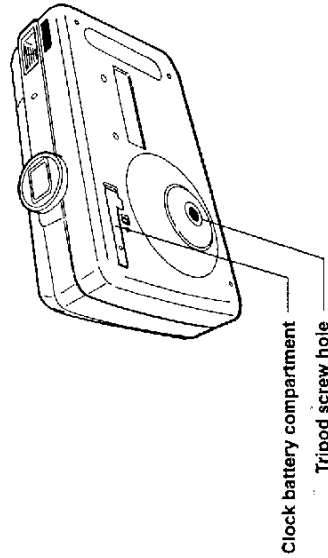

(Operation part)

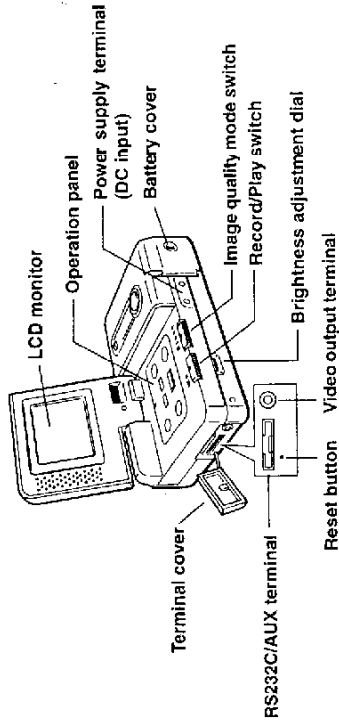

(Operation panel)

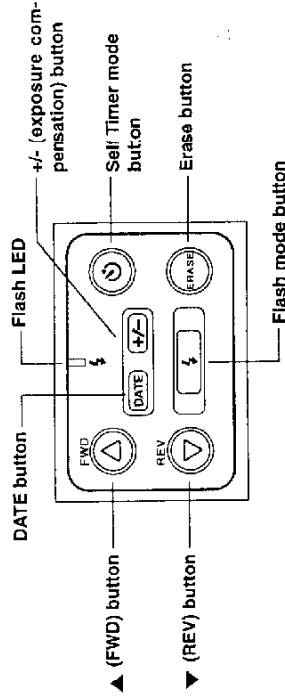

■ AC adaptor (sold separately)

- AC-2 (100V to 240V)
- AC-2100 (120V)

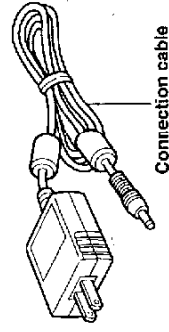
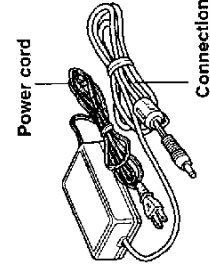

LCD Monitor Display

The camera status such as the battery condition, number of possible recordings, setting mode and other camera conditions are displayed as symbols and numbers on the LCD monitor.

■ Recording Display

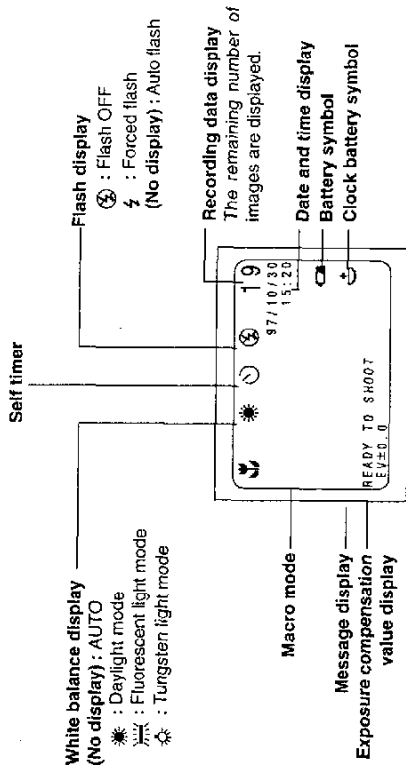

■ Playback Display

The file number is displayed.

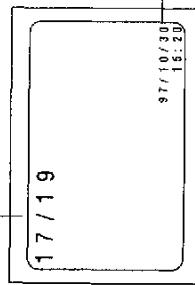

Note:

- All data is displayed simultaneously in this figure. However, only the necessary data is displayed.
- When the LCD monitor is opened, if no camera operations (button or switch operations) are performed for more than approximately five minutes, the "Auto Power Off" mode is set to conserve energy and the display of the LCD monitor goes off. (The battery is only used slightly in this condition.) Supply the power again or press the release button longer than one second to turn the power on.
- The auto power off setting can be changed. See page 56.

■ Alarm Display and Contents

When the following warning displays are displayed on the LCD monitor, verify the contents and perform the appropriate countermeasures.

Message	Condition	Description	Reference page
☹	Lights	This indicates that the batteries are depleted. Prepare new batteries.	P.17
⌚	Lights	The clock battery is depleted or the clock battery is not set. Replace or insert the batteries.	P.19

■ Error Display and Descriptions

When the following error display is indicated on the LCD monitor, verify the contents and perform the appropriate countermeasures.

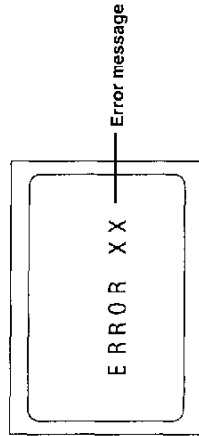

Error message	Description	Reference page
ERROR RECORD	The record is lost or damaged. Record the image again because the data that was recorded at this time may not be played back correctly. If the error message is still displayed, turn on the power again or press the reset button.	P.28 P.59
ERROR ERASE	The erase operation was not performed correctly. Turning off the power by closing the LCD monitor, then turn it on again and take a test image. If the test image data is erased, the incorrectly erased data will also be erased at this time. If the error message is still displayed, press the reset button.	P.52 P.28 P.59
ERROR PLAY	The playback is failed. Turn on the power again or press the reset button.	P.28 P.59
SYSTEM ERROR1 SYSTEM ERROR2 SYSTEM ERROR3	Turn on the power again. Otherwise, press the reset button.	P.28 P.59

* When problems cannot be solved even if the countermeasures described above are performed, please contact the store where you purchased the product or the local service representative.

TABLE OF CONTENTS

Introduction	1
Camera Description	2
Parts and Names	4
LCD Monitor Display	6
Table of Contents	8
Basic Operation • Quick Reference	11
Safety Precautions	16
Chapter 1. Getting Started	
Before Using the Camera	16
Confirming the package contents	16
Attaching the wrist strap	16
Supplying Power to the Camera	17
Inserting batteries	17
Inserting a Lithium Battery	19
Operation on AC Power	21
Before You Begin Recording	23
Adjusting the date and time	23
Adjusting the LCD	24
Holding the camera	25

Chapter 2. Recording Basics

Basic Picture-taking	28
Picture-taking sequence	28
Turning on the power	28
Selecting the image quality	29
Taking Pictures	30
Exposure compensation	32

Chapter 3. Picture-Taking Applications

Flash Mode	36
Selecting a Flash Mode	36
Flash off Mode	37
Forced Flash Mode	38
Auto Flash Mode	39
Setting the White Balance Mode	40
Selecting a White Balance Mode	40
Daylight mode	41

Fluorescent Mode	42
Tungsten Light Mode	43
Special Functions	44
Using the Self Timer	44
Macro Shooting (Close-up shooting)	45

Chapter 4. Picture Playback/Erasing

Before Playback	48
Information displayed during playback	48
Connecting a TV Monitor	49
File Playback	50
Operation flow	50
File playback	50
Automatic playback	51
File Erasing	52
Operation flow	52
Single-file erasing	52
Erasing all images	54

Chapter 5. Additional information

Changing a Camera Setting	56
Setting the auto power-off mode	56
Setting the power saving mode	57
Recording the setting contents	58
Returning the setting contents to the initial condition	59
System Configuration Figure	60
Accessories for RDC-300	62
Computer and DC Connections	63
Handling Precautions	66
Caring for Your Digital Camera	67
Troubleshooting	68
Using Your Digital Camera in Other Countries	71
Service	72
Specifications	74
Information to the User	76

Basic Operation • Quick Reference

This section describes the basic operations. Refer to the reference pages for further details.

Preparations

Inserting the batteries → Page 17 to 22

1 Insert the batteries.

When using the AC adaptor, connect the AC adaptor to the camera unit and then connect the adaptor to the wall outlet. See page 21.

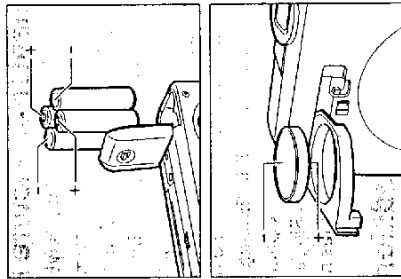

Setting the Date and Time → Page 23 to 24

1 Open the LCD monitor.

2 Set the date setting mode. Press and hold the DATE button for more than two seconds.

3 Change the numbers.

Press the ▲ button or the ▼ button to change the flashing numbers.

4 Change the position of the flashing number.

Each time the DATE button is pressed, the numbers to be corrected change.

* Press the DATE button repeatedly to select (in order) the year, month, data, hour and minute. When the selected date or time designation is flashing, press the ▲ button or the ▼ button to set the correct number's.

5 Start the clock.

After setting the minutes, press the DATE button again to start the clock.

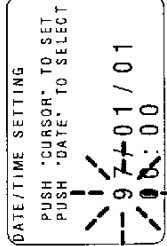
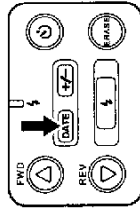

Picture-Taking

Picture-Taking (Basic picture taking) → Page 28 to 30

1 Turn on the power. The recording mode is set.

Open the LCD monitor and slide the RECORD/PLAY switch to the [REC] position.

2 Set the image quality mode.

Slide the image quality mode switch to select the image quality mode (F, N or E).

3 While viewing the LCD monitor, move the camera toward the shooting subject.

Press the release button lightly and make sure that the message "READY TO SHOOT." is displayed.

4 Start taking pictures.

Press the release button and take a picture.

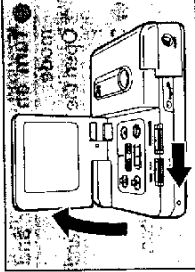

Changing the Flash Mode → Page 36 to 39

1 Turn on the power and set the recording mode.

Open the LCD monitor and slide the RECORD/PLAY switch to the recording position.

2 Change the flash mode.

Press the flash button and select either the flash off mode (⊘), forced-flash mode (⚡) or auto flash mode (no symbol display).

3 Take a picture.

Position the camera to frame the subject, and press the shutter release button to take the picture.

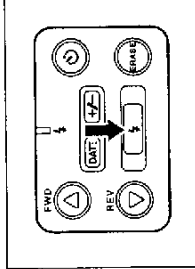

Using the Self-timer → Page 44

1 Turn on the power and set the recording mode.

Open the LCD monitor and slide the RECORD/PLAY switch to Record.

2 Set the self-timer mode.

Press the self-timer mode button and the self-timer (⌚) symbol will be displayed.

3 Take the picture.

Position the camera to frame the subject and press the shutter release button to take the picture.

* The self-timer lamp lights and the shutter is released after approximately 10 seconds.

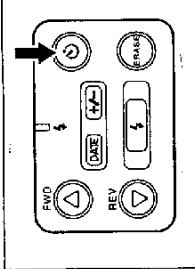

Playback and Erase

Playing Back a File Page 54

- 1 Turn on the power and set the playback mode.
Open the LCD monitor and slide the RECORD/PLAY switch to [PLAY].
- 2 Select the file.
Press the ▲ and ▼ buttons and select the file to playback.

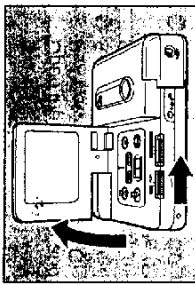

Erasing a File Page 52 to 54

- 1 Turn on the power and set the playback mode.
Open the LCD monitor and slide the RECORD/PLAY switch to [PLAY].
- 2 Set the erase mode.
Press the ERASE button.
- 3 Select the erase method.
Select either [ERASE] or [ERASE ALL] and press the RELEASE button.

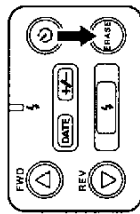

ERASE
CHOOSE WITH 'CURSOR'
AND 'PUSH'
'ERASE ALL'
EXIT

Single-image Erasing

- 1 Erase the files.
Press the ▲ and ▼ buttons and select the file to be erased. Press the RELEASE button. Repeat step 4 as desired.



Erasing All Images

- 1 Erase the file.
Press the RELEASE button.
* The erased file cannot be restored.
Check the contents of the file carefully before erasing the file.

ERASE ALL?
YES -- PUSH 'RELEASE'
NO -- PUSH 'ERASE'





Safety Precautions

Display

Various messages are displayed for this manual and product to enable you to use the product safely and prevent unexpected danger to people and damage to property.



- Warning** This symbol indicates operations which may result in a serious injury or even death if this message is ignored and incorrect operation is performed.
- Caution** This symbol indicates mishandling that may cause injuring to the users as well as or damage to objects if this message is ignored.

Display Example

-  Indicates a warning of a prohibited operation.
-  Specifically prohibited items are indicated in this warning.
- Display example
 -  Meaning: Touch prohibited.
 -  Meaning: Disassembly prohibited.

Observe the following precautions in order to use this equipment safely.

Warning

-  Turn off the power immediately if a fire, strange smell or abnormal condition occurs. Remove the batteries carefully, being careful to avoid electrical shock or burning. When the power is supplied from an electrical outlet, always remove the electrical plug from the wall outlet. Fire or shock may result otherwise. Contact your nearest service representative. Do not continue using this equipment when it is damaged or not operating correctly.
-  Turn off the power immediately if foreign matter (metallic objects, water or fluid, etc.) enter the internal parts. Remove the batteries, being careful to avoid electrical shock or burning. When the power is supplied from an electrical outlet, always remove the electrical plug from the wall outlet. Fire or shock may result otherwise. Contact your nearest service representative. Do not continue using this equipment when it is damaged or not operating correctly.



- When the LCD monitor is damaged, be careful not to touch the fluid inside the display. If any of the following conditions occur, perform the appropriate countermeasures immediately.
 - If liquid crystals contact the skin, wipe it off the skin and flush the affected area with plenty of water, then wash the area thoroughly with soap and water.
 - If any fluid gets in your eyes, rinse the eyes out with clean water for at least 15 minutes and contact a doctor immediately.
 - If someone drinks the fluid in the display, rinse out the mouth thoroughly with water and drink a large quantity of water and induce vomiting. Then, contact a doctor immediately.



- Observe the following precautions to prevent the batteries from leaking, exploding, catching fire or breaking.
 - Never use any type of batteries that are not specifically recommended for use with this camera.
 - Never dispose of the batteries in a fire, short-circuit the terminals, attempt to disassemble, heat, or recharge the batteries. (Only NiCad or nickel-metal-hydride (NiMH) batteries can be recharged.) Doing so may damage the batteries and cause a fire, injury or environmental contamination.
 - Do not use batteries incorrectly, such as batteries of a different type or name, batteries of a different manufacturer, or old batteries mixed with new batteries.
 - Be sure to maintain the correct polarity (positive [+], and negative [-] poles) when inserting the batteries.
 - Do not solder the batteries. This may damage the batteries and cause a fire, injury or environmental contamination.



- When using rechargeable batteries, do not mix them with other types of batteries or batteries in another charged condition.



- Be especially careful to store the batteries used in this product in a location which is not accessible to infants or children, to prevent the batteries from being swallowed accidentally. Contact a doctor immediately if the batteries are swallowed accidentally. This may result in severe personal injury.



- Never leave this product within the reach of infants or children. This condition may cause an accident because infants and children cannot understand the contents described in the sections Safety Precautions and Usage Precautions.



- Do not touch the inside of the camera with your hand is exposed to the internal components due to falling or other damage. The internal high-voltage circuits may cause an electrical shock. Remove the batteries right away, being careful to avoid electrical shock or burns. When the unit is damaged, contact the store where you purchased the product or the service representatives.



- Never attempt to disassemble, repair or modify the camera by yourself. There are internal high-voltage circuits which may cause severe electrical shock.



- Never use the camera in the bathtub or shower. This may cause fire or electrical shock.



- Do not use the unit near flammable gas, gasoline, benzene, thinner, etc. This may cause an explosion, fire or burns.
- Do not use the camera in an airplane or other location where usage is restricted. Using the camera in these locations may result in an accident.



- When dust accumulates on the electrical plug, wipe it off thoroughly. The dust may cause a fire.
- When using a household electrical outlet, always use the special AC adaptor (product name: AC-2, AC-2100 <110V area only>, optional). If a non-recommended AC adaptor is used, this may cause fire, shock or other damage.



- During travel to foreign countries, do not connect the AC adaptor to an electrical voltage transformer. This may cause fire, shock or other damage.

Observe the following precautions in order to use this unit safely.

Caution



● Fluid leaking from a battery can cause skin burns. If you touch a damaged battery, wash your hands with water immediately (do not use soap).
If fluid leaks from the batteries, wipe off the fluid and replace the batteries with new batteries.



● Make sure that the electrical plug is plugged securely into the wall.



● Do not get the camera wet. Do not touch the camera with wet hands. This may cause an electrical shock.



● Do not point the flash unit at the driver of a car, bicycle or train. This may cause an accident.



● To prevent fire and shock, do not use metal objects such as tweezers to grasp the batteries. This may cause a short-circuit.

Special Products

● When using products that are optional, such as the Ricoh remote controller and AC adaptor, read the section Safety Precautions in the operation manual for each product before operation.

Chapter 1. Getting Started

Before Using the Camera	16
Confirming the package contents	16
Attaching the wrist strap	16
Supplying Power to the Camera	17
Inserting batteries	17
Inserting a Lithium Battery	19
Operation on AC Power	21
Before You Begin Recording	23
Adjusting the date and time	23
Adjusting the LCD	24
Holding the camera	25

Before Using the Camera

Confirming the package contents

Check the packaging to ensure you have received the following items. Read the warranty, then store it in a safe place.

- Digital Camera (main unit) 1
- Video connection cable 1
- Soft Case 1
- AA Alkaline Batteries 4
- Lithium battery (CR2025) 1
- Wrist Strap 1
- Operation Manual (this document) 1
- Warranty card 1

Attaching the wrist strap

For security, always use the wrist strap when carrying the camera.

- 1 To attach the wrist strap, loop the leading end through the wrist strap eyelet of the camera.

Important

- Avoid swinging the camera when carrying it.

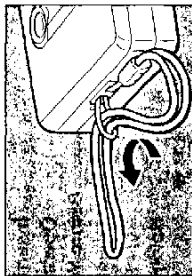

Supplying Power to the Camera

The procedures for loading the batteries (alkaline batteries, Lithium battery) are explained in this section. Electrical power supply by standard AC household current is also explained in this section.

Inserting batteries

Insert four AA alkaline batteries to begin using the camera. It is recommended to use the same type of batteries which are included in the package.

Note: The camera can also be powered by commercially available rechargeable nickel-cadmium (NiCad) batteries or nickel-metal-hydrate (NiMH) batteries. (It is recommended to use a high capacity type of battery for NiCad batteries.)

Warning



- Observe the following precautions to prevent the batteries from leaking, exploding, catching fire or breaking.
- Never use any type of batteries that are not specifically recommended for use with this camera.
- Never dispose of the batteries in a fire, short-circuit the terminals, attempt to disassemble, heat, or recharge the batteries. (Only NiCad or nickel-metal-hydrate (NiMH) batteries can be recharged.) Doing so may damage the batteries and cause a fire, injury or environmental contamination.
- Do not use batteries incorrectly, such as batteries of a different type or name, batteries of a different manufacturer, or old batteries mixed with new batteries.
- Be sure to maintain the correct polarity (positive [+] and negative [-] poles) when inserting the batteries.
- Do not solder the batteries. This may damage the batteries and cause a fire, injury or environmental contamination.



- When using rechargeable batteries, do not mix them with other types of batteries or batteries in another charged condition.



- Be especially careful to store the batteries used in this product in a location which is not accessible to infants or children, to prevent the batteries from being swallowed accidentally. Contact a doctor immediately if the batteries are swallowed accidentally. This may result in severe personal injury.

⚠ Caution



- Fluid leaking from a battery can cause skin burns. If you touch a damaged battery, wash your hands with water immediately (do not use soap).
If fluid leaks from the batteries, wipe off the fluid and replace the batteries with new batteries.

Rechargeable batteries

- Before using commercially available NiCad or NiMH batteries, read the safety precautions provided with each product thoroughly.

Important

- Use only specified AA-type batteries.
- Never use manganese batteries, lithium batteries or any other type of batteries that are not specifically recommended. Use of such batteries may damage the camera or LCD monitor.
- Some batteries may become hot after a long period of use. Remove the batteries after they have cooled off.

- 1 After confirming that the LCD monitor is closed, slide the lever to open the battery cover.

Note: See "Turning on the Power" on page 28 for information about the camera power supply.

- 2 Insert the batteries.

Important

- Carefully note the proper battery polarities (positive [+] poles and negative [-] poles).

- 3 Close the battery cover.

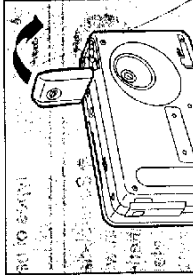
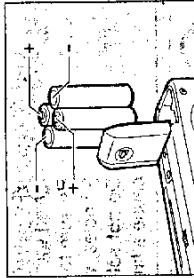
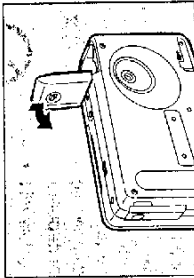

● Recording and playback capacities

The following table shows the number of recordable images and the playback time available with AA alkaline batteries (at temperatures between 10°C and 30°C).
< These capacities are based on Ricoh's measurement standards.>

Type of battery	Number of recordable standard images	Standard playback time
AA alkaline batteries	Approximately 150 images	Approximately 2 hours

- * The battery life varies according to flash usage and other variables.
- * Results may vary according to the type and brand of battery.

Note:

- Whenever you do not have access to an electrical outlet, always carry a spare set of batteries.
- The battery symbol (⚡) appears on the display panel to indicate that the batteries are weak or depleted. Prepare spare batteries.
- For rechargeable NiCad or NiMH batteries, the time between lighting of the battery symbol and complete depletion of the batteries is shorter than when alkaline batteries are used. The batteries run out quickly after the symbol lights.

■ Safety Precautions

- Do not use damaged batteries or batteries that are near the end of their service lives.
- Do not subject the batteries to strong impact.

Inserting a Lithium Battery

The lithium battery (CR2025) maintains the set date and time. Insert the lithium battery before starting to operate the camera.

⚠ Warning



- Observe the following precautions to prevent the batteries from leaking, exploding, catching fire or breaking.
- Never use any type of batteries that are not specifically recommended for use with this camera.
- Never dispose of the batteries in a fire, short-circuit the terminals, attempt to disassemble, heat, or recharge the batteries. (Only NiCad or nickel-metal-hydride (NiMH) batteries can be recharged.) Doing so may damage the batteries and cause a fire injury or environmental contamination.
- Be sure to maintain the correct polarity (positive [+] and negative [-] poles) when inserting the batteries.



- Be especially careful to store the batteries used in this product in a location which is not accessible to infants or children, to prevent the batteries from being swallowed accidentally. Contact a doctor immediately if the batteries are swallowed accidentally. This may result in severe personal injury.

⚠ Caution



- To prevent fire and shock, do not use metal objects such as tweezers to grasp the batteries. This may cause a short-circuit.

- 1 After confirming that the LCD monitor is closed, slide the lever with a ball point pen or similar items in the direction of the arrow.

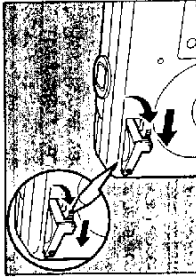

Note: See "Turning on the Power" on page 28 for more information on the power supply of the camera.

- 2 Pull out the battery holder.
- 3 Insert the lithium battery in the battery holder so that the positive (+) pole surface is facing down.

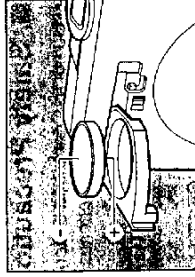

Important

- Use the lithium battery (CR2025) that is installed in the camera. Do not use any other types of batteries that are not specifically recommended.
- Be sure to maintain the correct polarity (positive [+] poles and negative [-] poles) when inserting the batteries.

- 4 Close the battery holder.

Note: The battery symbol (⊖ ⊕) appears in the display panel to indicate that the batteries are worn out or not inserted. Replace or insert the batteries.

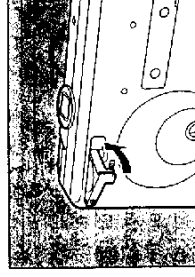

■ Safety Precautions

- The lithium battery (CR2025) maintains the set date and time. Battery life is approximately one year.
- To prevent imperfect contact, wipe off the batteries with a dry cloth before inserting them.
- Dispose of the batteries according to the local ordinances and regulations.

Operation on AC Power

If you intend to use your camera to record or playback over a long period of time, it is recommended to connect the camera to a household electrical outlet with the optional AC adaptor.

⚠ Warning



- When dust accumulates on the electrical plug, wipe it off thoroughly. The dust may cause a fire.
- When using a household electrical outlet, always use the special AC adaptor (product name: AC-2, AC-2100 <110V area only>, optional). If a non-recommended AC adaptor is used, this may cause fire, shock or other damage.



- During travel to foreign countries, do not connect the AC adaptor to an electrical voltage transformer. This may cause fire, shock or other damage.

⚠ Caution



- Make sure that the electrical plug is plugged securely into the wall.

About the AC Adaptor

Be sure to read the safety precautions in the manual supplied with the AC adaptor.

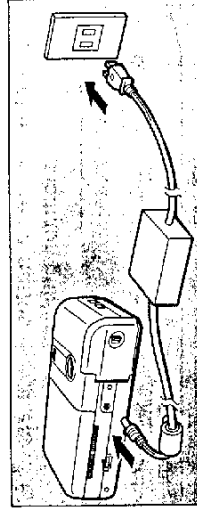

- 1 Confirm that the LCD monitor is closed.

Note: See "Turning on the Power" on page 28 for information about the camera power source.

- 2 Connect the connection cable of the AC adapter to the power terminal (DC input) of the camera.

- 3 Insert the plug into an electrical outlet.

Note: When the AC adapter is used with the camera, it becomes the active power source, even when the batteries are installed in the camera.

Important

- Plug the power cord firmly into the power source and into the camera. If the power plug or connecting cable loosens during recording, data could be lost or damaged.
- When the AC adapter is connected to the camera, the power supply to the camera is temporarily interrupted during the change of the power source. If this occurs while the camera is in use such as during recording, playback or erasing, data can be damaged or lost. Therefore, always turn off the power of the camera before connecting the AC adapter.

Before You Begin Recording

This section explains the initial camera adjustment and basic camera operations.

Adjusting the date and time

The camera records the date and time of every image that is recorded. You should set the correct date and time when you first begin using your camera, as well as when you travel to a different time zone.

Note:

- Input the date and time in the following format: yy/mm/ddd
- The camera uses a 24-hour clock, where 0:00 indicates midnight and 12:00 indicates noon.

- 1 Open the LCD monitor.

Note: The Recording/Playback switch can be set to either [REC] or [PLAY].

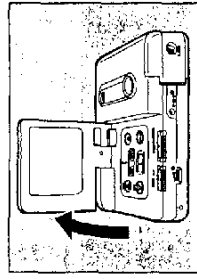

- 2 Press and hold the DATE button for more than two seconds.

The date setting mode is set.

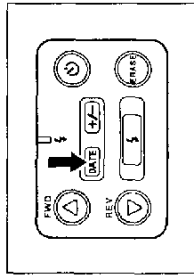

- 3 Press the ▲ button or the ▼ button to change the flashing numbers.

To advance the number

Press the ▲ button. Press and hold the button to fast-forward the numbers.

To reverse the number

Press the ▼ button. Press and hold the button to reverse the numbers rapidly.

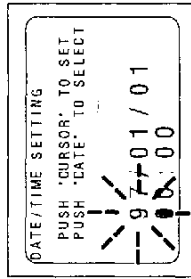

- 1 Press the DATE button so the item to be corrected starts flashing.

Repeat operation procedures 3 and 4 to correct the necessary items.

Note: Every time the DATE button is pressed, the year, month, day, hour and minute flashes in order.

- 2 After setting the minutes, press the DATE button again.

The clock starts and the LCD monitor display re-turns.

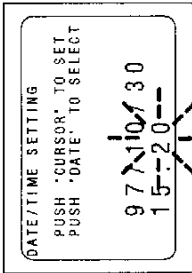
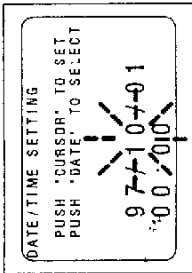

Adjusting the LCD

This section explains how to adjust the brightness and angle of the LCD monitor.

- 1 Turn the brightness adjustment dial to the right and left to adjust the appropriate brightness.

The brightness increases when turning the brightness adjustment dial to the right. It decreases when turning the brightness adjustment dial to the left.

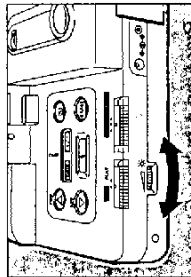

- 2 Move the LCD to the front and rear to obtain the optimal angle.

The LCD monitor can be adjusted between 60° and 140°.

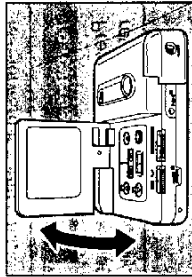

Holding the camera

Unintentional movement of the camera during shooting will result in blurred pictures. For best results, hold the camera steady when pressing the shutter release button.

- 1 Hold the camera securely with both hands and hold your elbows lightly against your side. Position the camera towards the subject and look at the LCD.

- 2 Place your fingers lightly on the shutter release button.

- When holding the camera in a high position:

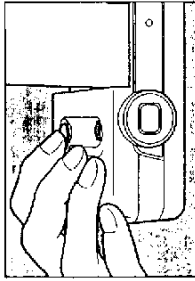
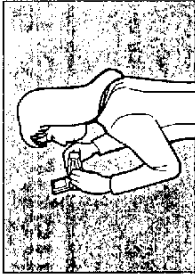

- When holding the camera in a low position:

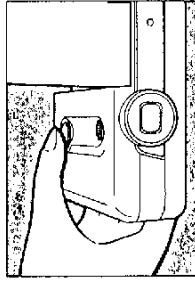
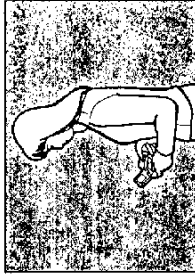

Important

- If you hold your finger too far from the shutter release button and press the button too fast, the camera may shake and a blurred picture may result.

Note: Holding the camera vertically will result in the subject being displayed sideways.

Be sure to keep your fingers or the wrist strap away from the camera lens and flash window.

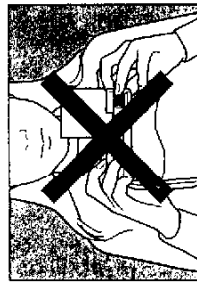

Chapter 2. Recording Basics

Basic Picture-taking	28
Picture-taking sequence	28
Turning on the power	28
Selecting the image quality	29
Taking Pictures	30
Exposure compensation	32

Basic Picture-taking

This chapter explains the basic operations and other information needed to record images.

Picture-taking sequence

The basic operation procedures are performed as follows.

Turn on the power.

Open the monitor and then slide the Recording/Playback switch to the [REC] side. See page 28.

Selecting the image quality mode.

Select the desired image quality of either F, N or E. See page 29.

Take the picture.

Press the shutter release button to record the images. See page 30.

Turning on the power

The power is turned on by opening the LCD monitor. (Approximately 60°)

1 Open the LCD switch and slide the RECORD/PLAY switch.

The lens cover opens and the power is turned on.

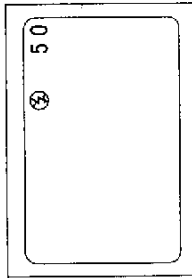
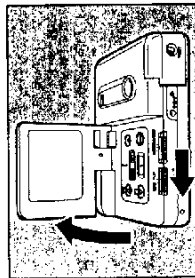

Note:

- When the power is turned on, the recorded data display and the flash display setting are displayed on the monitor in approximately three seconds.
- If the LCD monitor is closed, the power turns off and the lens cover closes.

Hint: Auto Power-Off Function
If no operations (levers or switches) are performed for five minutes or longer while the LCD monitor is opened, the Auto Power-Off function dims the LCD monitor display to save power. (This operation only requires a small amount of battery power consumption in this state.) To turn the power back on, press the shutter release button for more than one second and the power will be supplied.
The Auto Power-Off setting can be canceled. See "Setting Auto Power-Off" on page 56 for further details.

Note: When the Power-Off memory operates, the setting contents of the FLASH MODE, WHITE BALANCE MODE, AUTO POWER-OFF and INTERVAL TIME SETTING are saved at the values that were set just before the power was turned off. See "Recording setting contents" on page 58 for further details.

Selecting the image quality

This digital camera uses compression and decompression schemes that allow a large amount of information to be recorded. N (Normal) mode is standard, = (Fine) mode gives priority to picture quality and E (Economy) mode gives priority to the number of images that can be recorded. You can select the desired image quality for each image that is recorded. The number of pixels is set to the VGA resolution (640 (H) x 480 (V)).

■ Mode display on the monitor

Slide the image quality mode switch to set the mode.

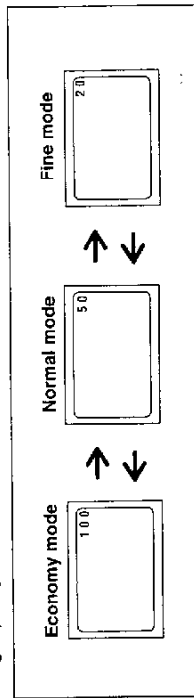

■ Selecting the image quality

1 Slide the image mode switch and select the desired mode (F, N, E).

The number of images that can be recorded is displayed in the recording data display on the LCD monitor.

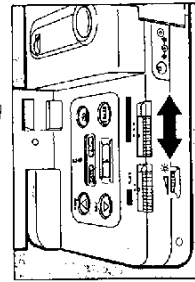

● **Standard Data**

Image Quality Mode	Data Size/Image
F mode	Approx. 160 KB/image
N mode	Approx. 80 KB/image
E mode	Approx. 40 KB/image

Note: The following chart indicates the maximum number of images that can be recorded when the image quality mode is switched.

Image Quality Mode	Number of Recorded Images
F mode	Approx. 25 images
N mode	Approx. 50 images
E mode	Approx. 100 images

Taking Pictures

This section explains the basic operations and other information need to record images.

Note: See "Holding the Camera" on page 25.

1 **Look through the LCD monitor and position the camera to compose the image.**

Use the macro mode to take pictures of subjects at distances from 1 to 60 cm.

Note: See "Macro Shooting" on page 45.



2 **Press the shutter release button halfway down.**

The shutter release button has two steps. Messages are displayed if the button is pressed halfway down. The exposure and white balance are set at this time.

● **Displayed Messages**

Pictures can be taken when the message "READY TO SHOOT" is displayed.

When the message "SLOW SHUTTER CHECK FLASH MODE" is displayed, use of the strobe flash is recommended because this indicates that the hand holding the camera is shaking.

Note: See "Selecting a Flash Mode" on page 36.

3 **Without releasing your finger, press the shutter release button gently.**

The self-timer lamp and flash lamp light during image recording to indicate that an image is recorded. If the image is recorded, the remaining number of images that can be recorded is displayed on the LCD monitor.

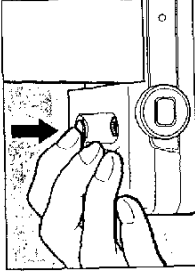

● **When forced flash or auto flash is set:**

When taking a flash photo in dark locations, the flash LED lights when the shutter release button is pressed lightly.

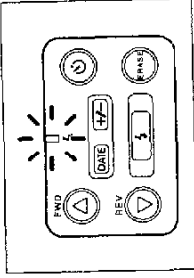

Note: The strobe lamp flashes when the flash is charging. A photo cannot be taken at this time.

Tips: When the camera is not used for a long period of time:

If no operation is performed for five minutes or longer while the power supply of the camera is turned on, the Auto Power-Off function dims the LCD panel to save power. Set the Auto Power-Off function off if a certain amount of time is required until a picture can be taken. Prepare a spare set of batteries because the batteries may be worn out if they are used for a long period of time. Connect an optional AC adapter to use a camera when power is supplied from a household electrical outlet.

Note: See "Setting the auto power-off mode" on page 56.

Tips: Switch the LCD monitor data display

When the recording mode is set, the LCD monitor data display can be set not to be displayed. The following screen is displayed when the flash button is pressed while pressing the ▲ and ▼ buttons. Press the ▲ or ▼ button to switch ON and OFF.

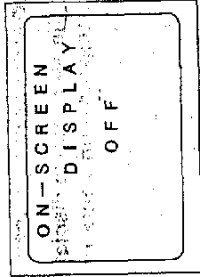
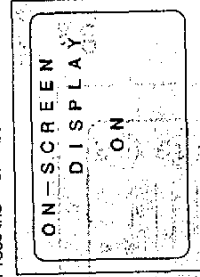

Exposure compensation

When there is a significant difference in brightness between the background and the subject or backlit condition, the subject may be underexposed (too dark) or overexposed (too light). In such cases, perform the exposure compensation. This function allows you to intentionally underexpose or overexpose an image.

- **Exposure compensation range**
± 2.0 EV (in 0.5 EV steps)

- **Shooting with backlighting**

When the background is bright, the subject is underexposed. In this case, adjust the exposure by increasing the value (positive (+) compensation).

Important

- In backlit conditions, place the subject at the center of the shooting range. If the subject is not placed at the center of the shooting range, the camera cannot determine the backlit conditions. In this case, perform the exposure compensation.

- **Shooting too light images**

When shooting an image which is too light, the entire image is underexposed. The image of the subject is recorded as too dark and light-colored subjects are recorded as grayish. In this case, increase the value to the positive (+) side to compensate the exposure.

- **Shooting too dark images**

When shooting an image that is too dark, the entire image is overexposed. The image of the subject is recorded as too light and light-colored subjects are recorded as grayish. In this case, increase the value to the negative (-) side to compensate the exposure. Follow the same procedures as when shooting an image of a person under direct light.

Exposure compensation setting

- 1 Press the +/- button to display the exposure compensation value on the LCD monitor.

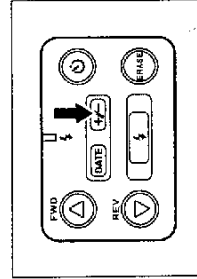

- 2 Press the ▲ or ▼ button to set the compensation value to be set. After adjusting the value, take the picture.

Adjusting the exposure by 0.5 EV

Press the ▲ button.

Reversing the adjustment value by 0.5 EV

Press the ▼ button.

To cancel the setting

Press the +/- button again.

Important

About the exposure compensation

- 1 To confirm the effect of the exposure compensation on the recorded image, watch the image that appears on the screen after the picture is taken, or playback the screen.
- 2 The exposure compensation value is retained in memory even when the exposure compensation setting is released. However, the exposure compensation setting only affects the images recorded when the exposure compensation mode is selected.

Chapter 3. Picture-Taking Applications

Flash Mode	36
Selecting a Flash Mode	36
Flash off Mode	37
Forced Flash Mode	38
Auto Flash Mode	39
Setting the White Balance Mode	40
Selecting a White Balance Mode	40
Daylight mode	41
Fluorescent Mode	42
Tungsten Light Mode	43
Special Functions	44
Using the Self Timer	44
Macro Shooting (Close-up shooting)	45

Flash Mode

This section explains how to change the flash mode. You can select the flash mode best suited to the lighting conditions.

Selecting a Flash Mode

Press the Flash mode button to select the desired mode.

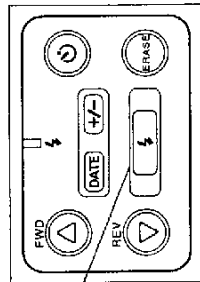

Flash mode button:
Sets the flash mode:

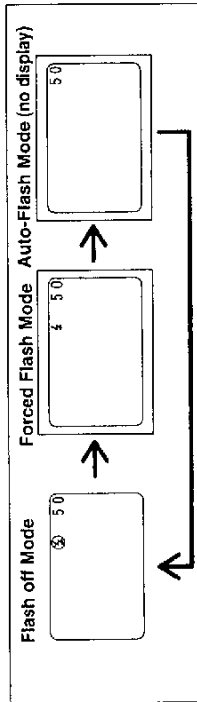

Important

- The white balance mode is set for the flash off mode and cannot be changed except when the AUTO mode (day/light mode, fluorescent light mode, tungsten light mode) is set. Perform the operations after changing the white balance mode to AUTO. See "Setting the White Balance Mode" on page 40.
- When performing macro shooting, the flash off mode is set and the flash mode cannot be changed.
- The light from the flash appears red in the picture if the flash discharges on the subject at a distance shorter than the minimum shooting distance (approximately 0.6m).

Flash off Mode

If this mode is used, the flash will not discharge even in dark locations. This feature is convenient when you wish to take a picture where flash photography is prohibited. It is also convenient for using the available room light when taking a picture.

- 1 Press the flash mode button until the [⊗] symbol appears on the LCD monitor.

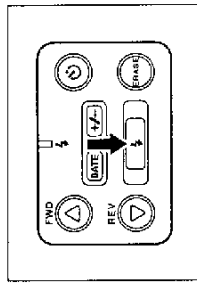

- 2 Press the shutter release button.

The camera will take a picture without the flash discharging.

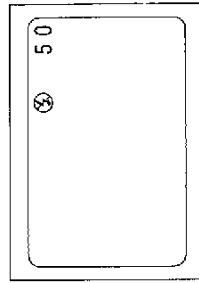

Important

- In dim light, the camera's shutter speed is automatically reduced and the message "SLOW SHUTTER CHECK FLASH MODE" is displayed. To prevent a blurred picture, hold the camera steadily or stabilize it with a tripod.

Canceling the selected flash Mode.

Press the Flash mode button again to select another mode.

Forced Flash Mode

When taking photographs of people under strong light or with backlighting, dark shadows may appear on the faces in the image. This mode is used to soften shadows. The flash is discharged under all lighting conditions.

- 1 Press the flash mode button until the [⚡] symbol appears on the LCD monitor.
The flash lights when the RELEASE button is pressed lightly.

Note: The flash lamp flashes while the flash unit is charging and a picture cannot be taken at this time.

- 2 Press the RELEASE button.

The camera will shoot a picture with the flash.

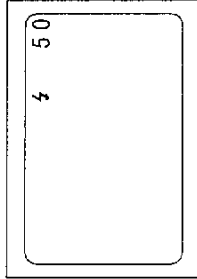
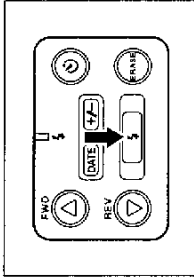

Canceling the Mode

Press the flash mode button to cancel the mode.

Flash Distance

The recommended flash shooting range is approximately 0.6 to 3.0m if the flash is discharged in daylight ("daylight synchro photography"). If the flash does not reach the subject, a dark underexposed image may result. If the lens-to-subject distance is less than 25cm (10 in.), the reflected image may look washed-out.

Auto Flash Mode

The flash discharges automatically when shooting in dark locations or in backlighting. Take the photo according to the lighting conditions.

- 1 Press the flash mode button to cancel the LCD monitor flash symbol (⚡ and 50).

When the flash discharges when shooting in a dark location, press the RELEASE button lightly and the flash lamp will light.

Note: The flash lamp flashes while the flash is recharging. A photo cannot be taken at this time.

- 2 Press the RELEASE button.

The flash will discharge automatically in dark locations or in backlighting.

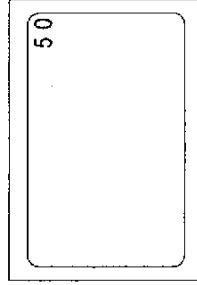
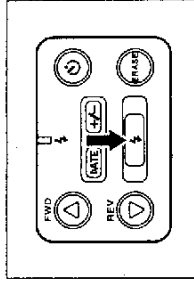

Canceling the Mode

Press the flash mode button to switch the mode.

Flash Distance

The shooting range is approximately 0.6 to 3.0m if the auto flash is used to shoot a picture. If the flash light does not reach the subject, a dark underexposed image may result.

Setting the White Balance Mode

The white balance mode is a function that adjusts the white balance so shooting can be performed in natural colors even under a light source. Normally this function is set under the AUTO mode.

To shoot a subject with natural hues, the white balance is automatically adjusted with the white portion used as reference. As a result, the white balance sometimes cannot be correctly adjusted when there is a small white area in the subject. If this occurs, set the white balance mode to the daylight mode, fluorescent mode or tungsten light mode and then take the picture.

Selecting a White Balance Mode

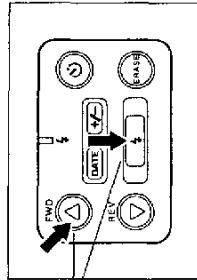

While pressing the ▲ button, press the flash button and set the white balance mode.

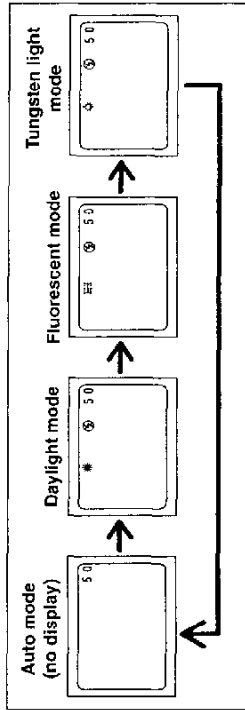

Subjects that the Auto White Balance may not work properly

- Monotone subjects.
- Subjects with multiple light sources.
- A deep background when shooting with the flash photo.

Note:

- In the AUTO mode, the white balance may not operate if there is an insufficient white area in the subject. In this case, move the camera to increase the white portion of the subject and then shoot the picture.
- The white balance mode can be performed only when the recording mode is set. It cannot be set when the playback mode is set.

Daylight mode

This daylight mode is used when shooting a picture outdoors and the auto white balance does not work properly.

- 1 Press the flash button while pressing the ▲ button.

The white balance setting mode is set.

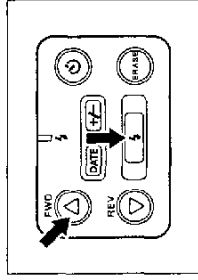

- 2 Press ▲ or ▼ button to display the ☀ symbol.

To set the daylight mode, either press the shutter release button or else perform no operation for three seconds.

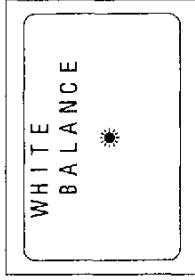

Important

- The flash off mode is set when the daylight mode is set. At this time, the flash mode cannot be switched even if the flash button is pressed.
- The color tone varies even for shooting the same subject depending on weather conditions such as sunny or cloudy lighting.

Canceling the Mode

Press the flash mode button while pressing the ▲ button to select the AUTO mode.

Fluorescent Mode

The fluorescent mode is used when shooting a picture under fluorescent lighting and the auto white balance does not work properly.

- 1 Press the flash button while pressing the ▲ button.

The white balance setting mode is set.

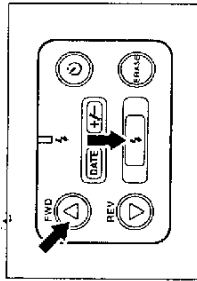

- 2 Press the ▲ or ▼ button to display the  symbol.

To set fluorescent mode, either press the shutter release button or else perform no operation for three seconds.

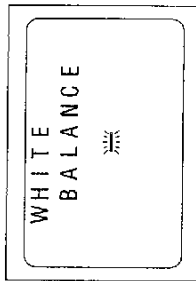

Important

- The flash off mode is set when the fluorescent mode is set. At this time, the flash mode cannot be switched even if the flash button is pressed.
- The color tone varies even for shooting the same subject depending on the type of the fluorescent light source.

Canceling the Mode

While pressing the ▲ button, press the flash mode button to select the AUTO mode.

Tungsten Light Mode

The tungsten light mode is used when shooting a picture under incandescent lighting the auto white balance does not work properly.

- 1 Press the flash button while pressing the ▲ button.

The white balance setting mode is set.

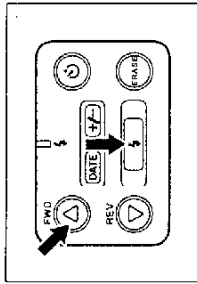

- 2 Press ▲ or ▼ button to display the  symbol.

To set the Tungsten light mode, either press the shutter release button or else perform no operation for three seconds.



Important

- The flash off mode is set when the tungsten light mode is set. At this time, the flash mode cannot be switched even if the flash button is pressed.
- The color tone varies even when shooting the same subject depending on the type of the incandescent light source.

Canceling the Mode

While pressing the ▲ button, press the flash mode button to select the AUTO mode.

Special Functions

This camera has a variety of special functions operated by setting certain modes other than the basic shooting procedures.

Using the Self Timer

This function is convenient for taking a group shot that includes the photographer. Before using the self timer, place the camera securely on a steady support or a tripod.

- 1 Press the self timer mode button to display the  symbol on the LCD monitor.

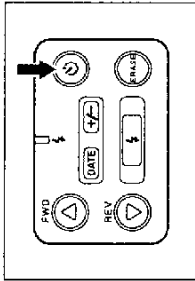

- 2 Frame the subject and make sure that the camera is positioned securely. Press the shutter release button.

The self timer light on the front of the camera lights and the self timer begins to count down. The shutter is released after approximately 10 seconds. The self timer light will flash for nearly two seconds before the shutter is released. The self timer mode automatically ends once the shutter is released.

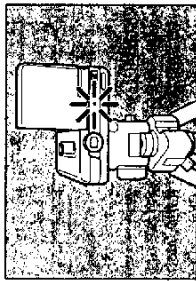

Note: The self timer mode cannot be activated when the flash is recharging. Wait until recharging is completed before starting the self timer shooting.

Column: About the remote control operation

Use this function with a optional remote control unit when releasing the shutter in the distance or when the camera is set in a fixed position.

Macro Shooting (Close-up shooting)

Macro shooting is tight close-up photography.

- 1 Approach the subject and compose the picture. Set the focus by turning the macro dial right or left.

If the macro dial is turned, the  symbol is displayed on the LCD monitor. Adjust the macro dial until the subject is displayed in the best condition.

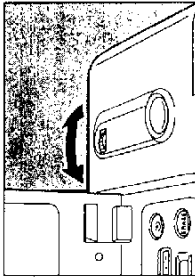

- 2 Press the shutter release button to take the picture.

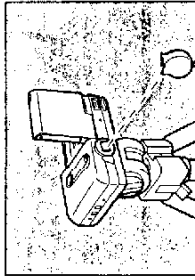

Important

- When the camera is repositioned, the subject may go out of focus because the accurate focus range for macro shooting is quite narrow. Position the camera on the a stable surface or tripod before taking a tight close-up.

Tips: About the shutter release button

The optional remote control unit is useful for releasing the shutter when the camera is stabilized on a tripod or on any other support.

Important

- The flash off mode is set when the macro mode is set. The flash mode cannot be switched at this time even if the flash button is pressed.
- The macro dial automatically returns to the original position when the LCD monitor is closed and the normal mode is set.

Chapter 4. Picture Playback/ Erasing

Before Playback	48
Information displayed during playback	48
Connecting a TV Monitor	49
File Playback	50
Operation flow	50
File playback	50
Automatic playback	51
File Erasing	52
Operation flow	52
Single-file erasing	52
Erasing all images	54

Before Playback

This section explains the preparation for the playback operations and the information about the playback images on the screen.

Information displayed during playback

The file number of the recorded image is displayed on the monitor for three seconds as shown in the following figure.

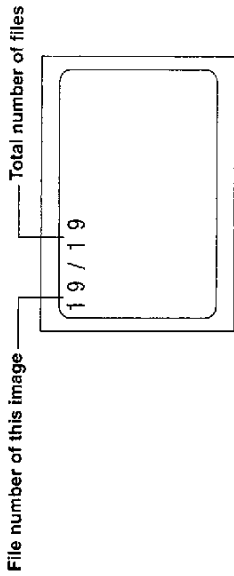

Note: The playback image is displayed as a picture condition which is taken while holding the camera horizontally. As a result, the subject which is taken while holding the camera vertically is displayed at a rotational angle of 90 degrees.

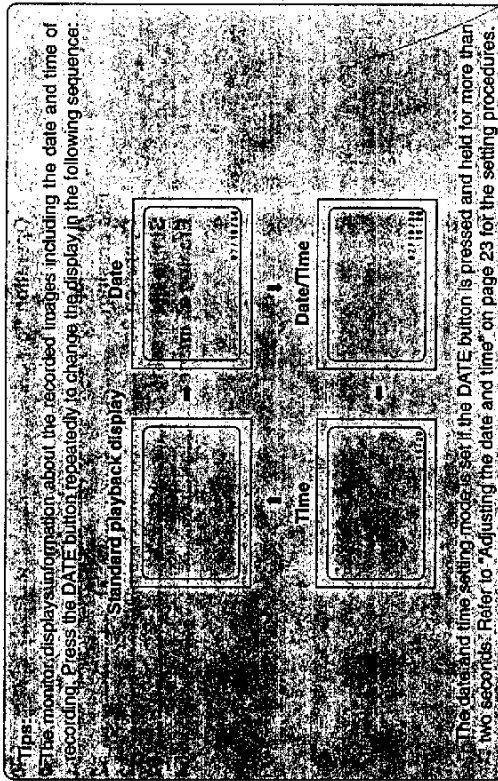

Connecting a TV Monitor

The recorded images can be played back on a TV monitor by connecting the Video cable to the camera and TV monitor.

Important

- Refer to the manual provided with the equipment that will be connected to for more information.

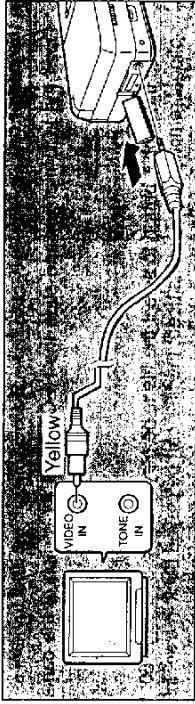

- Make sure that the power to the camera and the TV monitor is turned off.
- Remove the terminal cover of the camera and connect the Video cable to the video output terminal.
- Connect the opposite end of the Video cable to the VIDEO input terminal of the TV monitor.

Note: If the video connection cable is connected to the main unit of the camera, no image is displayed on the LCD monitor.

Extended playback

For extended playback, we suggest you use the optional AC adapter which obtains its power from a household electrical outlet. See "Operation on AC Power" on page 21.

- Be sure to turn off the power to the camera before connecting the AC adapter.

File Playback

This section explains the file playback procedures for recorded images.

Operation flow

The following is the basic explanation of the operation procedures.

Turn the power on.

Open the LCD monitor and slide the RECORD/PLAY switch of the camera to [PLAY].

Select the file.

Press the \blacktriangle or \blacktriangledown button to select the file to be played back. See page 50. If the optional remote control unit is used, the files can be played back in a set interval sequence. This is called the automatic playback function. See page 51.

File playback

The recorded file can be played back by pressing the \blacktriangle or \blacktriangledown button.

- 1 Open the LCD monitor, and slide the RECORD/PLAY switch of the camera to [PLAY].

The monitor displays the file that was recorded most recently.

Note: Refer to "Information displayed during playback" on page 48 for more information.

- 2 Press the \blacktriangle or \blacktriangledown button to select the file to be played back.

Selecting a forward file

Press the \blacktriangle button. If the button is held, the file is continuously advanced.

Selecting a reverse file

Press the \blacktriangledown button. If the button is held, the file is continuously reversed.

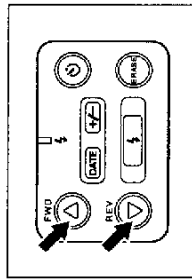
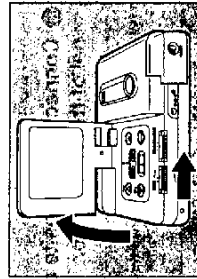

Automatic playback

The files are played back in a set interval sequence using the optional remote control unit. This is called the automatic playback function. The playback interval (time required to display images) can be set in the range from 0.5 to 30 seconds.

- 1 Press the program button of the remote control unit.

The interval time setting mode is set.

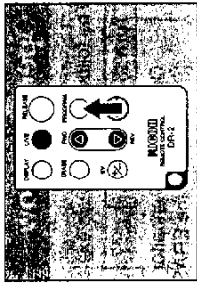

- 2 Press the \blacktriangle or \blacktriangledown button to select the playback interval.

The playback interval can be set in the range from 0.5 to 30 seconds.

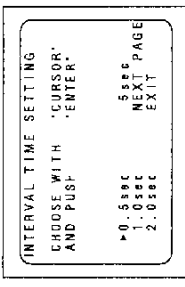

To display the previous or the next page

Select the previous page or the next page and press the ENTER button on the remote control unit.

To cancel the settings

Select [EXIT] and press the ENTER button.

- 3 Press the ENTER button of the remote control unit.

The automatic playback interval is set and the recorded files are played back in sequence.

To stop the playback

Press the ENTER button or PROGRAM button of the remote control unit.

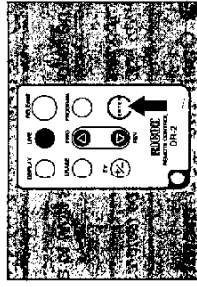

File Erasing

This section explains how to erase recorded files. There are two methods of erasing files: single-file erasing for erasing selected files individually, or all-file erase which erases all the files at one time.

Operation flow

The following is the basic explanation of the operation procedures.

Turn the power on.

Open the LCD monitor and slide the Record/Playback switch of the camera to [PLAY]. Press the ERASE button to set the erase mode.

Select the erase method.

Select the appropriate erase method to either erase a single file at a time or erase all the files at one time.

Select a file.

Select a file to be erased when erasing a single file.

Erase the file.

Erase the file.

See page 52 for information on single-file erasing.

See page 54 for information on all files erasing.

Single-file erasing

The following explains how to erase a specified file.

Important

- An erased file cannot be restored. Carefully confirm the contents of a file before erasing it.

- 1 Open the LCD monitor, and slide the RECORD/PLAY switch of the camera to [PLAY].

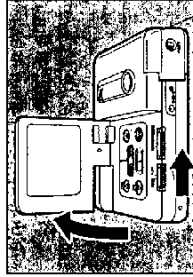

- 2 Press the ERASE button.

The erase mode is set.

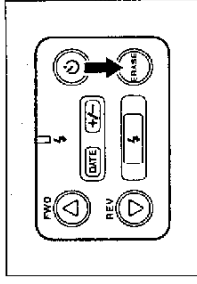

- 3 Press the ▲ or ▼ button to select [ERASE] and press the RELEASE button.

The single-file erase mode is set.

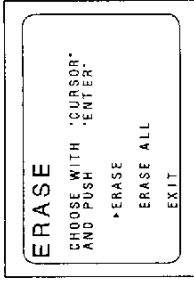

Note: To stop erasing, select [EXIT] and press the shutter release button.

- 4 Press the ▲ or ▼ button to select the file to be erased.

Note: To stop erasing, Press [ERASE] button.

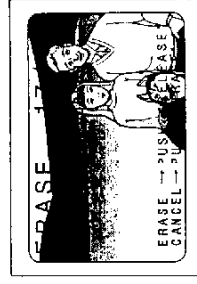

- 5 Press the RELEASE button.

The selected file is erased. Repeat steps 4 and 5 to erase another file.

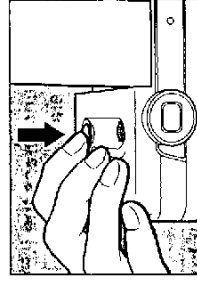

Note: When a file is erased, the file numbers of the succeeding files decrease by one.

Canceling the Mode

Press the ERASE button again.

Erasing all images

The following section explains how to erase all the files at one time.

Important

- Erased files cannot be restored. Carefully confirm the contents of files before erasing them.

- Open the LCD monitor, and slide the RECORD/PLAY switch of the camera to [PLAY].

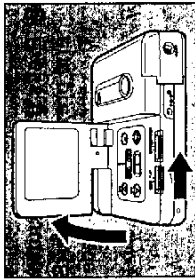

- Press the ERASE button.
The erase mode is set.

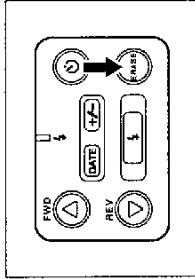

- Press the ▲ or ▼ button to select [ERASE ALL] and press the RELEASE button.
All file erase mode is set and the confirm message is displayed.

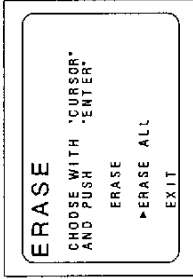

Note: To stop erasing, select [EXIT] and press the RELEASE button.

- Press the RELEASE button.
The erasing message is displayed and all files are erased. After erasing is finished the message "No image recorded" is displayed.

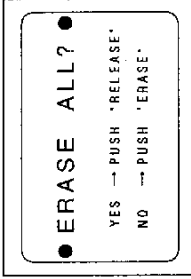

Note: To stop erasing, press the ERASE button.

Chapter 5. Additional information

Changing a Camera Setting	56
Setting the auto power-off mode	56
Setting the power saving mode	57
Recording the setting contents	58
Returning the setting contents to the initial condition ...	59
System Configuration Figure	60
Accessories for RDC-300	62
Computer and DC Connections	63
Handling Precautions	66
Caring for Your Digital Camera	67
Troubleshooting	68
Using Your Digital Camera in Other Countries	71
Servicing	72
Specifications	74
Information to the User	76

Changing a Camera Setting

This camera can change the settings such as "Auto Power-OFF", "Energy Saving" and "Power-Off memory" according to the usage purpose.

Setting the auto power-off mode

Two buttons or switches are operated for five minutes while the recording mode or playback mode is set, the Auto Power-OFF function operates to temporarily turn off the main power and conserve power.

To perform the following operations to cancel the Auto Power-OFF function.

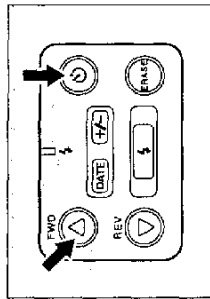

Press the Self button while the ▲ button is pressed.

The Record/Playback switch can be set to either the Record or Playback position. The Auto Power-OFF setting mode is set.

Press the ▲ or ▼ button to set the function OFF.

If the shutter release button is pressed or three seconds pass without performing any operations, the Auto Power-OFF will be set off.

To reset the Auto Power-OFF

Repeat the above operation to set the Auto Power-OFF function on. The Auto Power-OFF function starts again.

Note: If the LCD monitor display turned off by the Auto Power-OFF system, either perform, turn on the power again, slide the Record/Playback switch or press the shutter release button for one second or more.

Setting the power saving mode

This function prevents the battery from wearing by adjusting the LCD monitor brightness. A three-level setting from MODE 1 to MODE 3 can be set. However, the operations vary depending on whether the record mode and playback mode are set. Figure 57-1

Power saving mode	Record mode	Playback mode
OFF	Regular operation	Regular operation
MODE1	The LCD monitor is slightly dark. This condition remains until the setting is reset.	The LCD monitor is slightly dark. This condition remains until the setting is reset.
MODE2	The LCD monitor becomes dark. If the shutter release button is pressed lightly, the LCD monitor returns to the regular brightness. When the shutter release button is pressed and released, the picture is taken and the LCD monitor turns dark again.	This setting can be operated, however, the power saving function cannot be operated.
MODE3	The LCD monitor becomes dark. If the shutter release button is pressed lightly, the LCD monitor becomes slightly dark. When the shutter release button is pressed and released, the picture is taken and the LCD monitor turns dark again.	Same as MODE 1.

Perform the following operations when the power saving mode is set.

1 Press the +/- button while pressing the ▲ and ▼ buttons.

The Record/Playback switch can slide to either Record or Playback. The power saving setting mode is set.

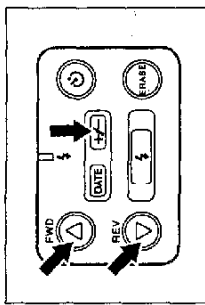

2 Press the ▲ or ▼ button to select the power saving mode.

If the shutter release button is pressed or three seconds pass without any operation, the power saving mode is set.

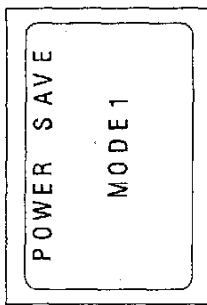

To cancel the setting

Repeat the operation described above to set if the power saving mode off. The power saving function is turned off.

Important

The power saving mode setting is automatically canceled when the power is turned off. When the camera is used in an environment where the temperature is approximately 40°C or higher, the LCD monitor display may have a certain uneven quality. If this occurs, the condition will return to normal when the temperature decreases.

Note: Depending on the environment in which the camera is used, the power saving mode can vary because in the number of recording files can be 1.2 times greater than usual and the playback time is approximately 2.5 hours.

Recording the setting contents

The power off memory function is to maintain the setting contents when the power is turned off. If the power is turned off when the power off memory is set, the function contents of "Flash mode (see page 36.)", "White balance mode (see page 40.)", "Auto power-off (see page 56.)" and "Auto playback interval (see page 51.)" are memorized and they are maintained when the power is turned on next time.

Press the Self button while the ▲ and ▼ buttons are pressed.

The Record/Playback switch can be slide either Record or Playback. The power-off memory setting mode is set.

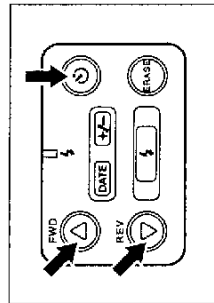

Press ▲ or ▼ button to set ON.

If the shutter release button is pressed or approximately three seconds pass without any operation, the power-off memory is set on.

Cancel the setting

Repeat the above operation to set it off. The power-off memory function is turned off.

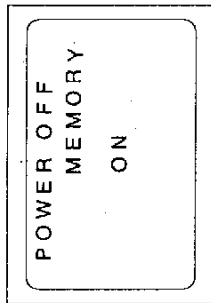

Note: When the power-off memory is set on, the setting contents of "Flash mode", "White balance mode", "Auto Power-Off" and "Auto playback interval" are maintained. The setting contents other than these functions are reactive and return to the initial conditions when the power is turned on again.

Returning the setting contents to the initial condition

This section explains how to reset the setting contents of the "Flash mode", "White balance mode", "Auto Power-OFF", "Interval time setting" and "Power off memory" and return to the initial setting when the camera was shipped.

Remove the terminal cover on the side of the camera and press the reset button with the tip of a sharp pencil or similar object.

The settings are reset when the batteries or the clock batteries are installed. The recorded images are not erased even after a reset is performed.

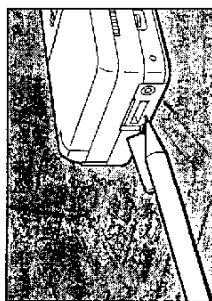

Important

Do not use a sharp object or material that breaks easily to press the button.

System Configuration Figure

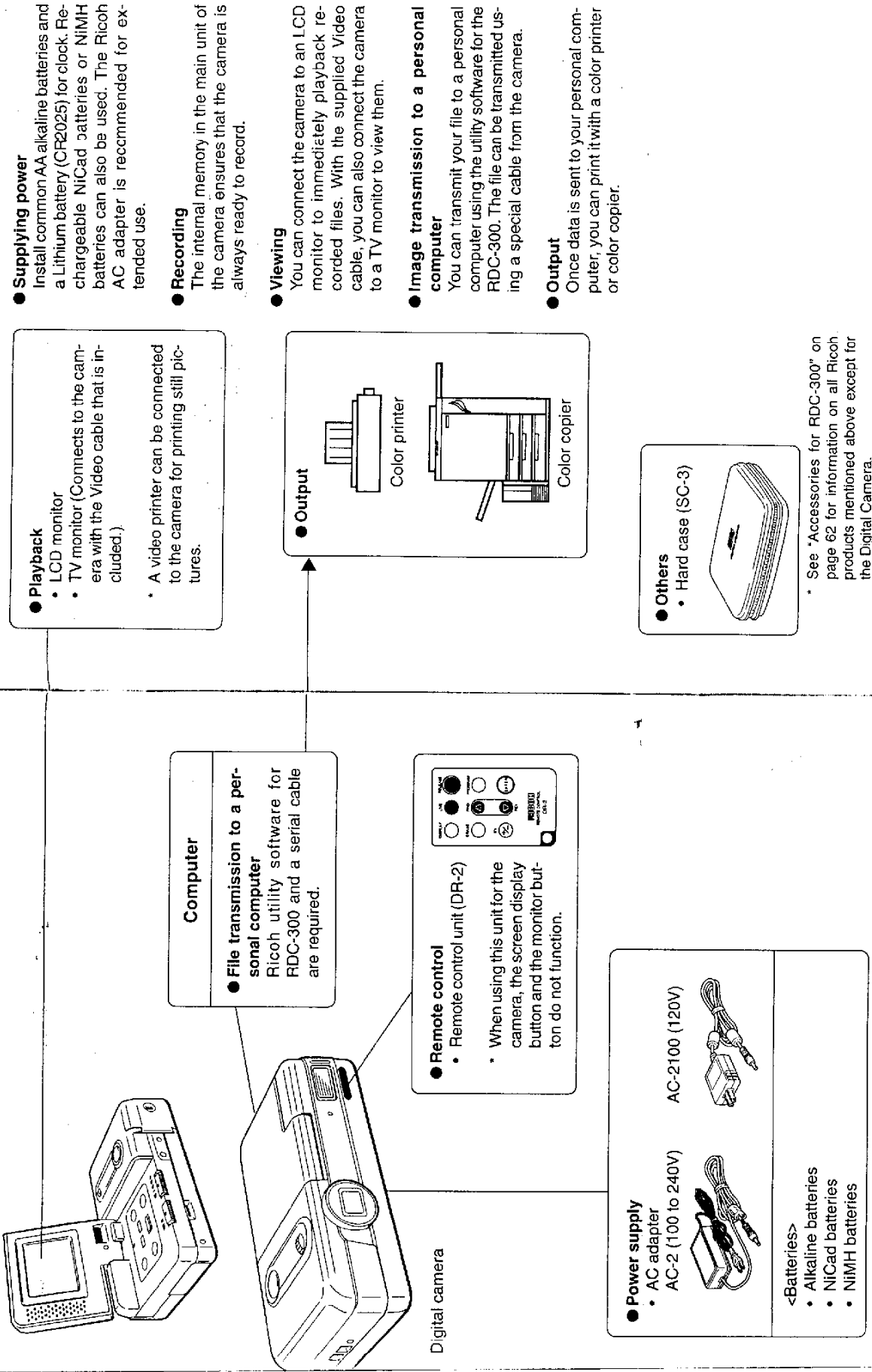

● **Supplying power**

Install common AA alkaline batteries and a Lithium battery (CR2025) for clock. Rechargeable NiCad batteries or NiMH batteries can also be used. The Ricoh AC adapter is recommended for extended use.

● **Recording**

The internal memory in the main unit of the camera ensures that the camera is always ready to record.

● **Viewing**

You can connect the camera to an LCD monitor to immediately playback recorded files. With the supplied Video cable, you can also connect the camera to a TV monitor to view them.

● **Image transmission to a personal computer**

You can transmit your file to a personal computer using the utility software for the RDC-300. The file can be transmitted using a special cable from the camera.

● **Output**

Once data is sent to your personal computer, you can print it with a color printer or color copier.

● **Playback**

- LCD monitor
- TV monitor (Connects to the camera with the Video cable that is included.)

* A video printer can be connected to the camera for printing still pictures.

● **Output**

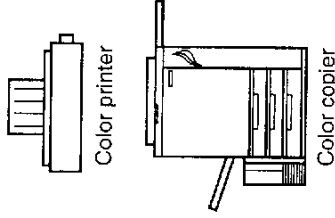

● **Others**

- Hard case (SC-3)

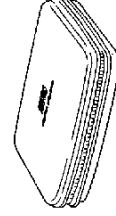

* See "Accessories for RDC-300" on page 62 for information on all Ricoh products mentioned above except for the Digital Camera.

● **Power supply**

- AC adapter AC-2 (100 to 240V)
- AC-2100 (120V)

<Batteries>

- Alkaline batteries
- NiCad batteries
- NiMH batteries

Accessories for RDC-300

AC Adapter	AC-2	For operating on household AC current. See p.21, "Operation on AC Power."
	AC-2100	For operating on household AC current. See p.21, "Operation on AC Power." (110V area only)
Hard Case	SC-3	Storage and carrying case for the camera and LCD Monitor.
Remote Control Unit	DR-2	For recording or playback by remote control. Features a programmed playback function (a presentation tool that enables you to program the sequence of pictures to be played back). This function is available only with this Remote Control Unit.

The corporate names and brand names stated above are trademark or registered trademarks of their respective corporations.

Computer and DC Connections

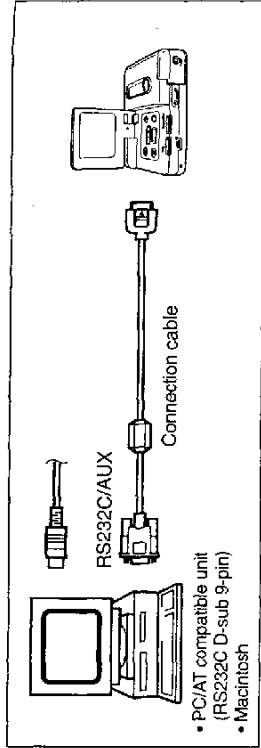

- PC/AT compatible unit (RS232C D-sub 9-pin)
- Macintosh

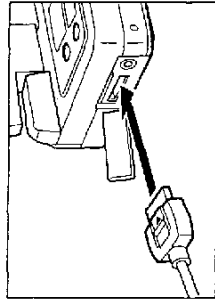

1. Open the side cover of the camera.
2. Insert the connection cable terminal to the RS232C/AUX terminal.

3. Connect the cable to the computer.

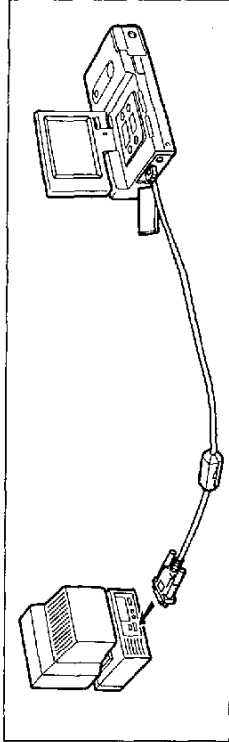

For the Mac:

Select the [New catalogue] from the [File] menu.
Note: To import an image into a catalogue that already exists, select [File] and [Open the catalogue] to select the import destination catalogue.

Input the new catalogue name in the dialogue box and click the [Save] button.

The new catalogue window is displayed.

Slide the Record/Playback switch of the camera to [Playback].

Select [Load from Ricoh Camera] in the [File] menu.

The dialogue box is displayed.

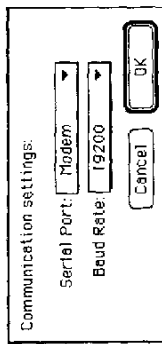

Set the serial port and the communication speed and click the [OK] button.

Note: When connecting to the camera through the printer port, set the [Apple Talk] item to [Not used] in the [Selector] of the Apple menu.

When the computer and the camera are connected correctly, the following dialogue box is displayed.

Select the image to be imported.

- To specify one image at a time
Press the [-] button or the [>] button to select the import image and click the [Select] check button. Repeat the operation and specify the images to be imported in image sequence.

- To specify all images

Click the [Select all] button. All images that are recorded in the camera are selected.

Note: When the image selection is canceled, remove the check in the [Select] check box or click the [No select] button. The image that is currently selected is canceled.

After selecting the image, click the [OK] button.

The specified image is imported.

Note: • It is recommended to use an AC adapter when images are uploaded or downloaded. The file transfer operations will be interrupted if the power is cut off during the operation.

- Refer to the on-line HELP menu in the software for further details. The Acrobat Reader should be installed to view the HELP menu.

For Windows:

Download files from the camera

- 1 Select [DOWNLOAD RICOH FILES] from the [FILE] menu.
- 2 Specify the communication speed and the serial port for the cable connection. Select if a file is to be added to the album or only developed on the desktop as necessary.

Then select the format the file should be saved in.

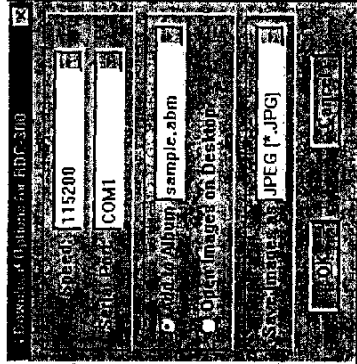

- 3 Click [OK] to start download.

Note: • It is recommended to use an AC adapter when images are uploaded or downloaded. The file transfer operations will be interrupted if the power is cut off during the operation.

- Refer to the on-line help menu in the software for further details.

Handling Precautions

This camera is not waterproof. Take great care to avoid water, rain or spilled drinks. If the camera gets wet, contact your local Ricoh service office.

Never drop the camera or subject it to strong shock.

To avoid overheating the system, do not continuously operate the built-in flash unit more than is necessary.

Protect the camera from sand or dust, especially at the beach or in dusty environments (construction sites, etc.).

Do not expose the camera to high temperatures or high humidity as for long periods of time such as in a closed car, beach, or bath.

Turn off the camera before connecting it to the optical AC adapter.

Sudden changes of temperature may cause condensation to form inside and outside the camera body and lens, resulting in malfunctions. If this occurs, place the camera into a bag or plastic bag temporarily to moderate any drastic change of temperature. Keep it in the bag until the temperature difference is minimized.

If the LCD monitor is exposed to sunlight or other bright light, it may appear white and difficult to observe.

Some times a pixel which always lights or does not light is present in the LCD monitor. The brightness may have an unevenness due to the characteristics of the LCD. However, these are not malfunctions.

Do not pull the terminal cover with excessive force or lift up the camera with it.

Do not open the LCD monitor while holding the lens cover.

Always close the LCD monitor when carrying the camera.

Condensation occurs when

- The camera is suddenly brought into a warm place from a cold place.
- The camera is used in a location subject to high humidity.
- The camera is used in a room right after it has heated up or was in a location subject to direct cool wind from an air conditioner.

Caring for Your Digital Camera

■ Camera Care

- Keep the lens of the camera clean, as stains or dirt on the lens may degrade the precision of the image quality.
- Do not attempt to remove dust or smears on the lens with your fingers. Use a blower to blow the dust away, or wipe the surface gently with a soft cloth.
- After using the camera at the beach or exposing it to a chemical environment, take special care to wipe off any dirt.
- If the camera does not operate properly, contact a Ricoh service representative. The camera is equipped with a hazardous high-voltage circuit. Never attempt to repair the camera by yourself.
- Keep the camera away from volatile liquids such as thinner, benzene and insecticide, as these chemicals may peel off the paint or damage the surface.
- Do not scrub on the surface of the LCD monitor with a hard object because it is easy to be scratched or damaged.
- Wipe off the surface of the LCD monitor with a moistened soft cloth with thinned detergent and wipe off the moisture with a dry cloth.
- Remove the batteries and AC adaptor from the camera before cleaning.

■ Safekeeping

- Do not store the camera in a closet with insect repellents, as these may damage the camera and cause a malfunction.

Troubleshooting

Before sending the unit for repairs, first refer to the following checklist for a possible solution to the problem. If you still cannot correct the problem, please contact the Ricoh service representatives.

Power Source Problems

Problem	Cause	Solution
No power	The batteries are not positioned properly or are depleted.	Reposition the batteries correctly or replace with fresh batteries.
	The AC adapter is not connected properly.	Reconnect the AC adapter.
Sudden loss of power	The Auto Power-Off system shuts down the camera after several minutes of inactivity.	Press the shutter release button more than one second or turn on the power again.
	The batteries are depleted.	Replace the old batteries with fresh batteries.
The batteries go dead quickly.	The batteries were subjected to excessively low or high temperatures.	—
	The built-in flash was used too many times because of dark conditions or other reasons.	—

Shooting and Playback Problems

Problem	Cause	Solution
The camera fails to record picture when shutter release button is pressed.	The batteries are not inserted properly (incorrect polarity) or are dead.	Reposition the batteries correctly or replace with fresh batteries.
	The power is off, or the Record/Playback switch is set to [Playback].	Slide the main switch to [Record].
	The shutter release button is not fully pressed down. (Button was pressed only halfway down.)	Press the shutter release button all the way down.
	The internal memory is full.	Delete some files to secure enough space.
	The Self Timer mode is selected.	Press the Self Timer mode button to cancel the Self Timer mode.
	The flash is recharging.	Wait until the flash lamp stops flashing.
The flash does not work or recharge.	No-flash mode is selected.	Press the flash mode button to cancel the setting.
	The fixed white balance mode or macro mode is set.	Press the flash button while pressing the ▲ button to cancel the white balance mode or rotate the macro dial to cancel the mode.
	The batteries are dead.	Replace with fresh batteries.

Problem	Cause	Solution
The flash discharged properly but the image is dark.	The distance to the subject exceeds approximately 3.0 meters.	Reduce the distance to the subject.
The picture is too bright.	The flash discharged when distance to subject was less than 60 cm.	Select the no-flash mode.
	The image is overexposed.	Compensate the exposure with the +/- button.
	The brightness adjustment dial is not set correctly.	Turn the brightness adjustment dial to right or left to adjust the brightness.
	The picture was taken in the no-flash mode under dark conditions.	Press the flash mode button to cancel the setting.
	The image is underexposed.	Compensate the exposure with +/- button.
	The brightness adjustment dial is not set correctly.	Turn the brightness adjustment dial to the right or left to adjust the brightness.
	The image conditions prevent the automatic white balance system from functioning properly.	Include a white or light-colored object in the subject, or use the flash or fixed white balance.
	The Record/Playback switch is not set to [Playback].	Slide the Record/Playback switch to [Playback].
	Video connection cable is not correctly connected to the video output terminal of the camera and the input terminal of the TV.	—
	A noise source such as a motor is close to the camera.	Place the camera where it is not close to a noise source.
	Malfunction in the camera's internal memory.	Back up any important images in the internal memory by file transmission to a computer or by other functions. Then erase all the files.
	The batteries are dead.	Replace the batteries with fresh batteries.
	The Auto Power-Off system has activated.	Close the LCD monitor to turn off the power and then turn on the power again or press the shutter release button more than one second.
	There is an obstruction in the path between the reception window of the camera and the transmission window of the remote control unit.	Clear the path between the camera and the remote control unit.
	The reception window on camera or transmission window on the remote control unit is dirty.	Clean both windows.
	The lithium battery in the remote control unit is dead.	Replace with the battery a fresh lithium battery (CR2032).
	This condition occurs when a picture is taken of a well-lit subject. It is called a smear.	This is not a malfunction.

Other Problems

Problem	Symptoms	Solution
The camera buttons and switches do not function.	The batteries are dead. The camera does not function properly.	Replace the batteries with fresh batteries. Close the LCD monitor to turn off the power once and then set the camera to [Record] or [Playback]. If the camera still fails to function properly, try the following: 1. Remove and reinstall all batteries in the camera. 2. Set the camera [Record] or [Playback] again.
The date is incorrect.	The correct date and time have not been set.	Reset the time and date correctly.
The date display is turned off.	The batteries are dead.	Replace the batteries with fresh batteries and reset the date.
The camera fails to erase a file.	The Record/Playback switch is not set to [Playback].	Slide the Record/Playback switch to [Playback].
The camera changes to a mode other than the one selected.	The power was shut off manually or the Auto Power-Off function turned off the power to the camera.	Select the mode again.
The Auto Power-Off system does not work.	The batteries are removed. The Auto Power-Off system is set off.	Select the mode again. Confirm the Auto Power-Off system setting.

Using Your Digital Camera in Other Countries

Ricoh AC-2 AC adapter (optional)

- The AC-2 AC adapter adjusts automatically to voltages ranging from 100 to 240V AC and frequencies of 50 to 60 Hz.
- Some countries use electrical outlets which have different shapes. Before leaving on a trip, obtain the necessary plug adapter from a travel agent or electric store.

Ricoh AC-2100 AC adapter (optional)

- The AC-2100 AC adapter can only be used in locations where 120V AC is used.

About the warranty

- A wide range of power supplies can be used from 110V to 240V and 50 Hz or 60 Hz.
- In countries where the power connector type is different than the electrical plug equipped with the camera, be sure to check with the local service representative before using a conversion adaptor.

Viewing the Image on a TV Monitor

- Make sure to check if the TV monitor operates in the NTSC format with a image input terminal.
- The optional video connection cable is required.

- The NTSC format is used in the following countries.

American Samoa Barbados Bermuda Bolivia Canada Chile Columbia Costa Rica Cuba Democratic People's Republic of Korea	Dominican Republic El Salvador Ecuador Guam Guatemala Haiti Honduras Japan Mexico Micronesia Myanmar	Nicaragua Panama Peru Philippines Puerto Rico Surinam Taiwan Trinidad and Tobago USA Venezuela
--	--	---

servicing

The Ricoh RDC-300 camera is backed by a one-year limited warranty. During the warranty period, which starts from the date of purchase, any defective parts will be repaired free of charge. In the event of a camera malfunction, contact the dealer where you purchased the camera or contact the nearest Ricoh service representatives. Please note that you will be charged for the cost of shipping the camera from the Ricoh service center to you.

This warranty does not cover any damage resulting from:

- ① Failure to follow the instructions in this instruction manual;
- ② Repair, modification or overhaul not conducted by authorized service station specified in this instruction manual;
- ③ Fires or natural disaster;
- ④ Improper storage, such as exposing the camera to high temperatures, humidity, or insect repellents; storing it with leaking batteries; storing the camera in a dirty condition so that it becomes moldy; or otherwise insufficiently caring for the camera.
- ⑤ Submergence; exposure to floods or spilled alcoholic or beverages; allowing sand or mud to enter the camera; exposure to physical shocks; or dropping of the camera.

After a full year has passed from the purchase date, you will become responsible for all repair fees, including those incurred at authorized service station.

You will be responsible for all repair fees, even within the warranty period, if the warranty card is not attached or if the distributor's name or the purchase date have been changed or are not indicated on the card.

Expenses for overhauls and thorough inspections as a result of the customer's special request will be charged to the customer, whether or not they occur during the warranty period.

This warranty only applies to the camera and not to the accessories such as the hard case and wrist strap, nor does it apply to the consumables provided, such as batteries.

Any consequential damage arising from the failure of this camera, such as expenses for taking pictures or loss of expected profit, will not be reimbursed whether they occur during the warranty period or not.

The above provisions refer to repairs offered free of charge, and do not limit your legal rights. The intention of the above provisions are also described in the warranty card provided with this camera.

Parts essential to the servicing of this camera - that is, components required to maintain the functions and quality of this camera - will be available for a period of seven years after the camera is discontinued. However, as some of those parts are kept for a longer period, do not hesitate to contact your distributor or the nearest Ricoh service representative even after the seven-year period.

Please note that, if the camera is seriously damaged from flooding, submergence, infiltration of sand or mud, violent shocks or dropping, the camera may not be repairable, and restoration to its original condition may be determined to be impossible.

Note:

- Before sending the camera in for repair, check the batteries and read this instruction manual again to ensure proper operation.
- Some repairs require a significant amount of time to be completed. Please allow sufficient time for repairs.
- When sending the camera to a service representative, please include a note which describes the defective part and the problem as precisely as possible.
- Remove all accessories not related to the problem before sending the camera to a service representative.
- Before taking any important pictures such as at weddings, on trips abroad, etc.) test the camera to check its operation and ensure proper functioning. We recommend that you keep this manual and fresh batteries on hand.

Specifications

General

Video signal method

• Standard

Batteries

AC

• Dimensions (W × H × D)

Weight

• Operating humidity range

• Operating temperature range

• Storage temperature range

Camera

CCD

• Pixels

• Focal length

• Minimum shooting range

• Macro shooting range

• Composition

• Monitor Display

• Screen size

• Drive system

• Picture elements

• Brightness adjustment

• Color temperature

• Standard setting

• Automatic adjustment range

• Fixed adjustment range

• Exposure adjustment

• AE range

• Light measuring system

• EV memory system

• Exposure mode

• Exposure measurement

• AE with flash

• Shutter speeds

• Focusing

• ISO sensitivity

• NTSC

• 6V

• 5V

• 125.8 mm (W) × 34 mm (H) × 72.6 mm (D) (excluding protruding parts)

• Approx. 230g without batteries

• less than 85%

• 0°C to 40°C

• -20°C to 60°C

• 1/4", 350,000 pixels (effective 330,000 pixels VGA) with complementary color checkers

• Single reflex F: 3.8

• f:4 mm (equivalent to a 38 mm lens on a 35mm camera)

• Approx. 60 cm

• Approx. 1 cm to 60 cm

• 5 elements in 5 groups

• 1.8 type (36.9 mm (W) × 27.5 mm (H))

• TFT active matrix system

• 61,380 dots (279 (H) × 220 (V))

• Brightness adjustment dial is attached.

• 4200 + 50K

• -50K

• 2800K to 8000K

• Fluorescent light 4000K

• Outdoor 5100K

• Incandescent light 3200K

• EV6.3 to EV17

• Centerweighted

• With automatic backlight control program

• Manual exposure adjustment range ±2.0EV (in 0.5 EV increments)

• Program AE

• TTL CCD method

• Included (with daylight synchro)

• Still picture: 1/4 to 1/16000 (electronic shutter)

• F 2.8 fixed

• Equivalent to ISO 80

Distance adjustment

- Fixed: Approx. 60 cm to ∞
- Manual adjustment: Approx. 1 cm to 60 cm

Built-in flash

- Method
- Interval between flash
- Effective distance
- G no.
- Operating modes

The Flash is turned off when the macro mode and fixed white balance mode are set.

Image Data Recording

Internal memory

- 4 MB
- 640 × 480 (VGA)
- JPEG (Exif)

• Based on the JPEG base line method.

Compression method

- Economy mode
- Normal mode
- Fine mode

• Approx. 100 files

• Approx. 50 files

• Approx. 25 files

• 5 V (AC adapter)

• 1.0 Vp-p (75Ω)

• Special

• 1/4-20 UNC

• 5.7 mm max. bolt length

• AA alkaline batteries

• AA NiMH batteries

• AA NiCad batteries

• 6 V (1.5V × 4 cells)

• Lihium battery CR2025

• 3 V 160mAh

• Approx. 1 year

• Activates when camera is not used for approx. 5 minutes.

Clock Battery

Battery type

- Voltage
- Service life

Auto Power-OFF System

INFORMATION TO THE USER

USA FCC Part 15 Class B

This equipment has been tested and found to comply with the limits for a Class B digital device, pursuant to part 15 of the FCC Rules. These limits are designed to provide reasonable protection against harmful interference in a residential installation. This equipment generates, uses, and can radiate radio frequency energy and, if not installed and used in accordance with the instructions, may cause harmful interference to radio communications. However, there is no guarantee that interference will not occur in a particular installation. If this equipment does cause harmful interference to radio or television reception, which can be determined by turning the equipment off and on, the user is encouraged to try to correct the interference by one or more of the following measures:

- Reorient or relocate the receiving antenna.
- Increase the separation between the equipment and receiver.
- Connect the equipment into an outlet on a circuit different from that to which the receiver is connected.
- Consult the dealer or an experienced radio/TV technician for help. (FCC 15.105B)

Changes or modifications not expressly approved by the party responsible for compliance could void the user's authority to operate the equipment. (FCC 15.21)
Properly shielded and grounded cables and connectors must be used for connection to host computer in order to meet FCC emission limits. (FCC 15.27)

COMPLIANCE INFORMATION STATEMENT

Product Name: Ricoh Digital Camera

Model Number: RDC-300

This device complies with Part 15 of the FCC Rules.

Operation is subject to the following two conditions:

- (1) This device may not cause harmful interference, and
- (2) This device must accept any interference received, including interference that may cause undesired operation.

RICOH CORPORATION

475 Lillard Drive

Sparks, Nevada 89434

PHONE NUMBER: 702-352-1600

FAX NUMBER: 702-352-1615

CANADA Class B

This Class B digital apparatus meets all requirements of the Canadian Interference-Causing Equipment Regulations.

Cet appareil numérique de la classe B respecte toutes les exigences du Règlement sur le matériel brouilleur du Canada.

IMPORTANT SAFETY INSTRUCTIONS-SAVE THESE INSTRUCTIONS DANGER-TO REDUCE THE RISK OF FIRE OR ELECTRIC SHOCK, CAREFULLY FOLLOW THESE INSTRUCTIONS.

Ricoh Service Representatives

Ricoh Company, Ltd.
3-32-3 Higashi-Shinagawa
Shinagawa-ku, Tokyo
140 JAPAN
<http://www.ricoh.co.jp/>

Ricoh Corporation
475 Lillard Drive
Sparks, Nevada 89434
U.S.A.
<http://www.ricohcpj.com/>

Ricoh Europe B.V.
Groenelaan 3
P.O. Box 114
1180 AC Amstelveen
Holland
<http://www.ricoh-red.com/>
<http://www.ricoheurope.com/>
E-mail: camera@ricoh.nl

Ricoh Photo Products(Asia), Ltd.
Unit D, E&F,
24/F., China Overseas Building,
139 Hennessy Road, Wan Chai
Hong Kong

Ricoh Australia Pty. Ltd.
148 Highbury Road,
Burwood, Victoria, 3125,
Australia